

USAN80/200/80

Short description

Asymmetrical transition piece 80/200, where D = 80mm



Article number 0055.0670

Technical data

Material	Sheet steel, Sendzimir galvanised
Weight including packaging	0 kg
Width with packaging	0 mm
Height with packaging	0 mm
Depth with packaging	0 mm
Packing unit	1 piece
Range	K
GTIN (EAN)	4012799556701

Dimensioned drawing [mm]

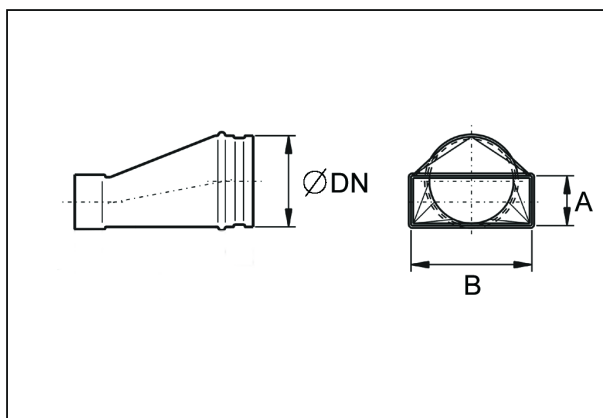

DN	A	B
80	80	200