

USSN55/220/100



Short description

Symmetrical transition piece 55/220, where D = 100mm,

Article number 0055.0677

Technical data

Material	Sheet steel, Sendzimir galvanised
Weight including packaging	0 kg
Nominal size	100 mm
Channel dimension	220 mm x x 55 mm
Width with packaging	0 mm
Height with packaging	0 mm
Depth with packaging	0 mm
Packing unit	1 piece
Range	K
GTIN (EAN)	4012799556770

Dimensioned drawing [mm]

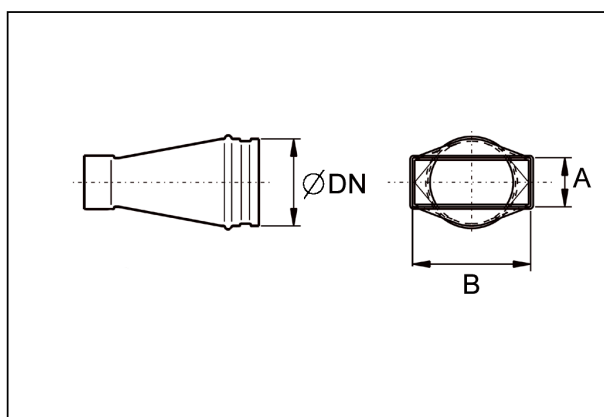

DN	A	B
100	55	220