

USSN70/170/80

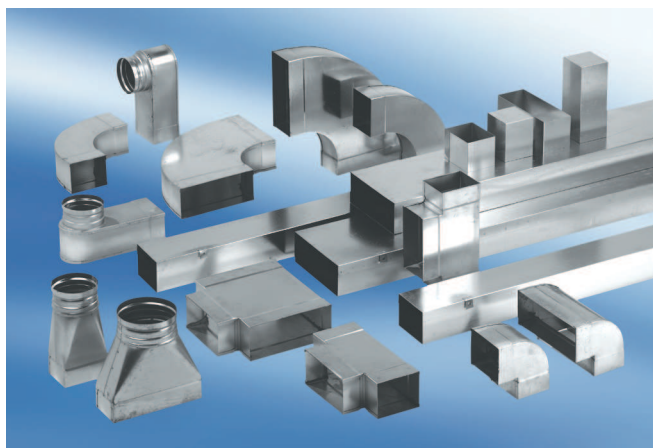

Short description

Symmetrical transition piece 70/170, where D = 80mm,

Article number 0055.0679

Technical data

Material	Sheet steel, Sendzimir galvanised
Weight including packaging	0 kg
Width with packaging	0 mm
Height with packaging	0 mm
Depth with packaging	0 mm
Packing unit	1 piece
Range	K
GTIN (EAN)	4012799556794

Dimensioned drawing [mm]

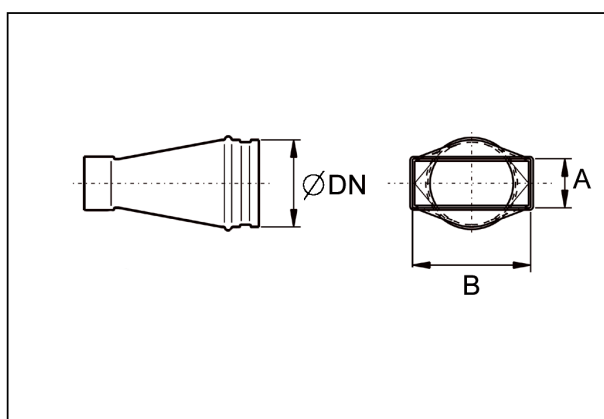

DN	A	B
80	70	170