

USSN80/200/100



Short description

Intermediate piece 80/200, where D = 100 mm,

Article number 0055.0688

Technical data

Material	Sheet steel, Sendzimir galvanised
Weight including packaging	0 kg
Nominal size	100 mm
Channel dimension	200 mm x x 80 mm
Width with packaging	0 mm
Height with packaging	0 mm
Depth with packaging	0 mm
Packing unit	1 piece
Range	K
GTIN (EAN)	4012799556886

Dimensioned drawing [mm]

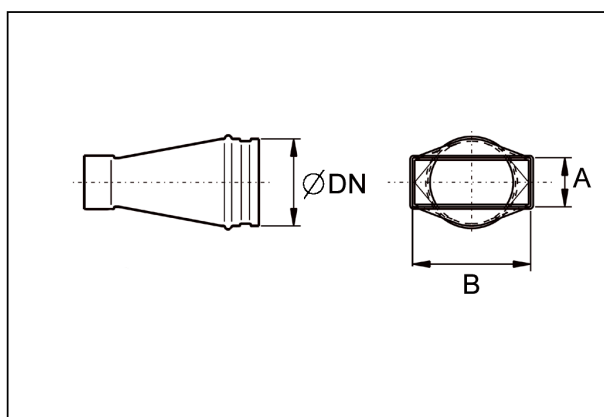

DN	A	B
100	80	200