

# USSN80/200/150

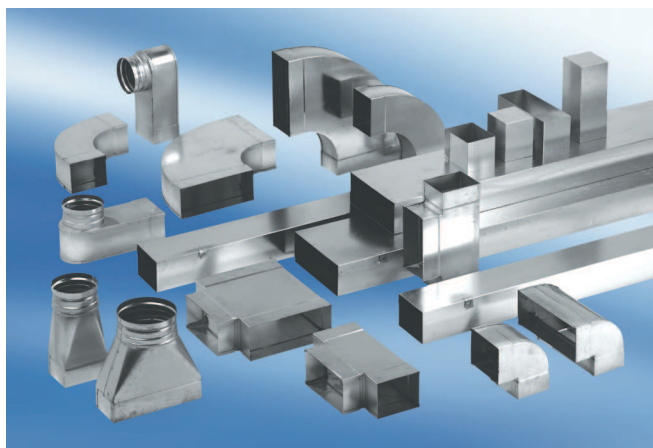

## Short description

Intermediate piece 80/200, where D = 150 mm,

Article number 0055.0690

## Technical data

Material	Sheet steel, Sendzimir galvanised
Weight including packaging	0 kg
Nominal size	150 mm
Channel dimension	200 mm x x 80 mm
Width with packaging	0 mm
Height with packaging	0 mm
Depth with packaging	0 mm
Packing unit	1 piece
Range	K
GTIN (EAN)	4012799556909

## Dimensioned drawing [mm]

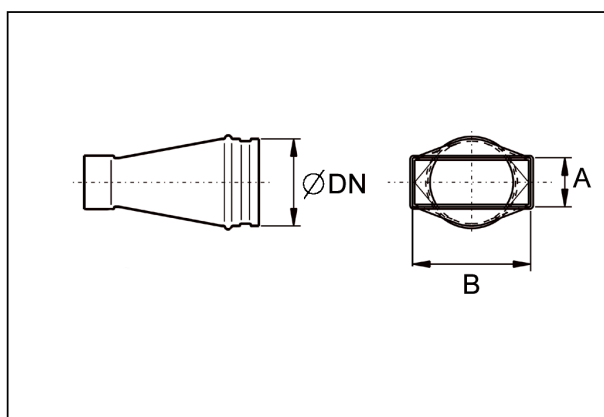

DN	A	B
150	80	200