

# VD 50-Ex

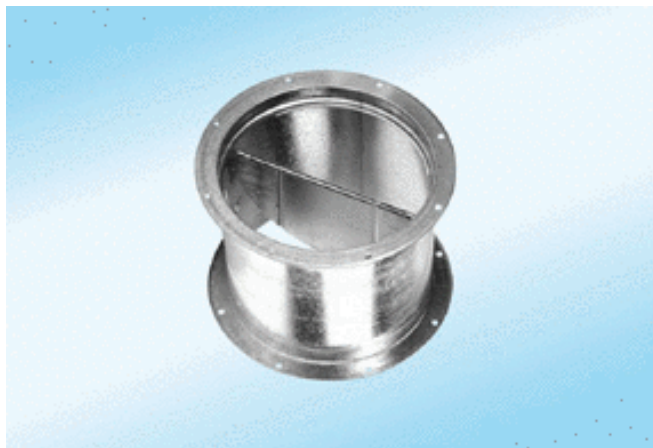

## Short description

Shutter with pull device, airstream operated opening, explosion proof

Article number 0093.0635

## Technical data

Weight	6,6
Type of shutter	Airstream-operated opening/closing
Suitable for nominal size	500 mm
Explosion protection	Ex II 2G
Ex version	antistatic
Packing unit	1 piece
Range	C
GTIN (EAN)	4012799936350

## Characteristic curve Pressure losses

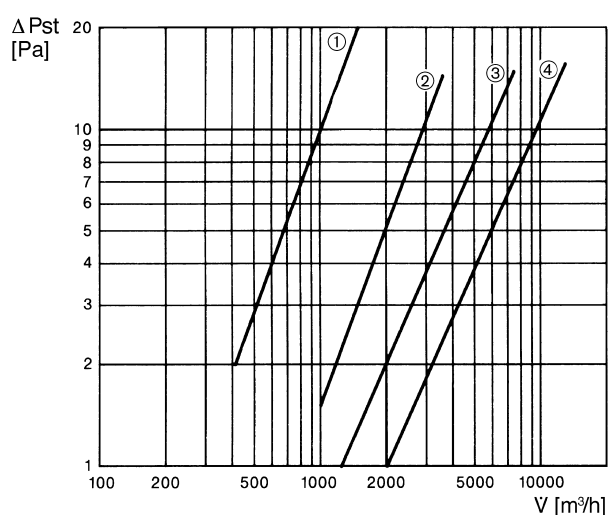

- ① VD 25-Ex
- ② VD 30-Ex
- ③ VD 35-Ex, VD 40-Ex, VD 50-Ex
- ④ VD 60-Ex

# VD 50-Ex

Dimensioned drawing [mm]

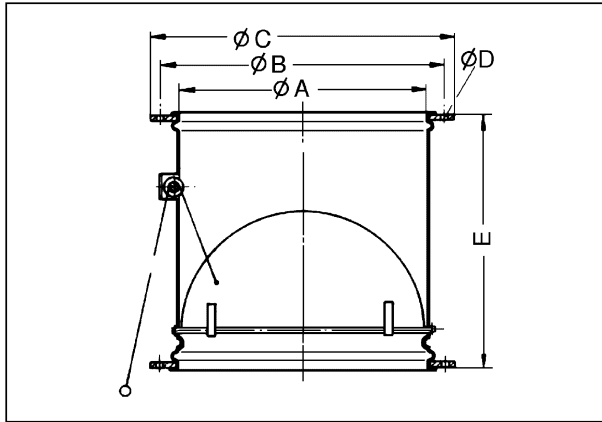

A	B	C	D	E
513	541	565	9	420