

VH 25



Short description

Sheet steel wall sleeves, for fans with the nominal size 250

Article number 0055.0031

Technical data

Installation site	Wall / Ceiling
Material	Sheet steel, galvanised
Weight	1,3 kg
Weight including packaging	1,31 kg
Suitable for nominal size	250 mm
Width	276 mm
Height	276 mm
Depth	200 mm
Width with packaging	276 mm
Height with packaging	276 mm
Depth with packaging	200 mm
Packing unit	1 piece
Range	C
GTIN (EAN)	4012799550310

VH 25

Dimensioned drawing [mm]

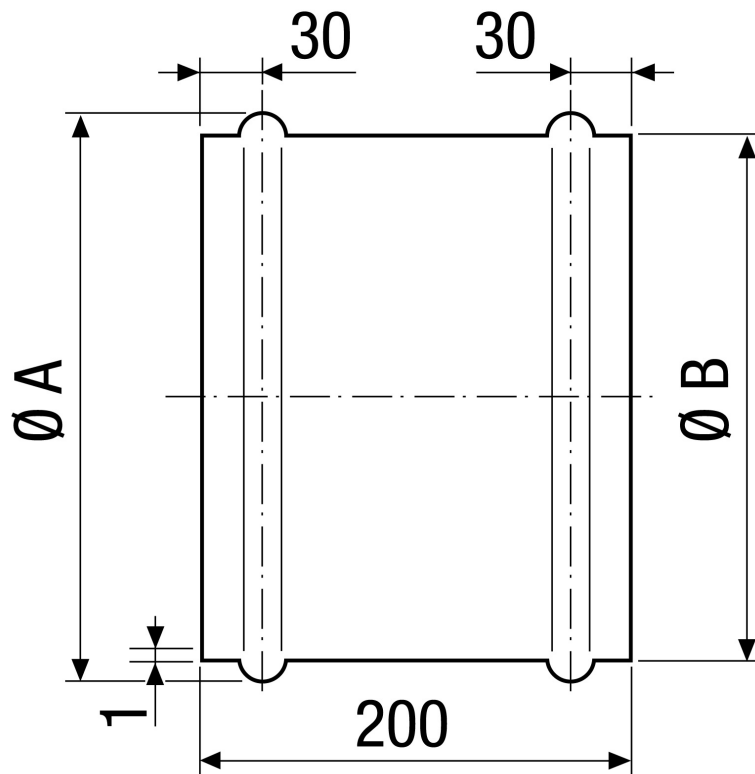

A	B
276	269