

VH 35



Short description

Sheet steel wall sleeves, for fans with the nominal size 350

Article number 0055.0033

Technical data

Installation site	Wall / Ceiling
Material	Sheet steel, galvanised
Weight	1,8 kg
Weight including packaging	1,82 kg
Suitable for nominal size	350 mm
Width	376 mm
Height	376 mm
Depth	200 mm
Width with packaging	376 mm
Height with packaging	376 mm
Depth with packaging	200 mm
Packing unit	1 piece
Range	C
GTIN (EAN)	4012799550334

VH 35

Dimensioned drawing [mm]

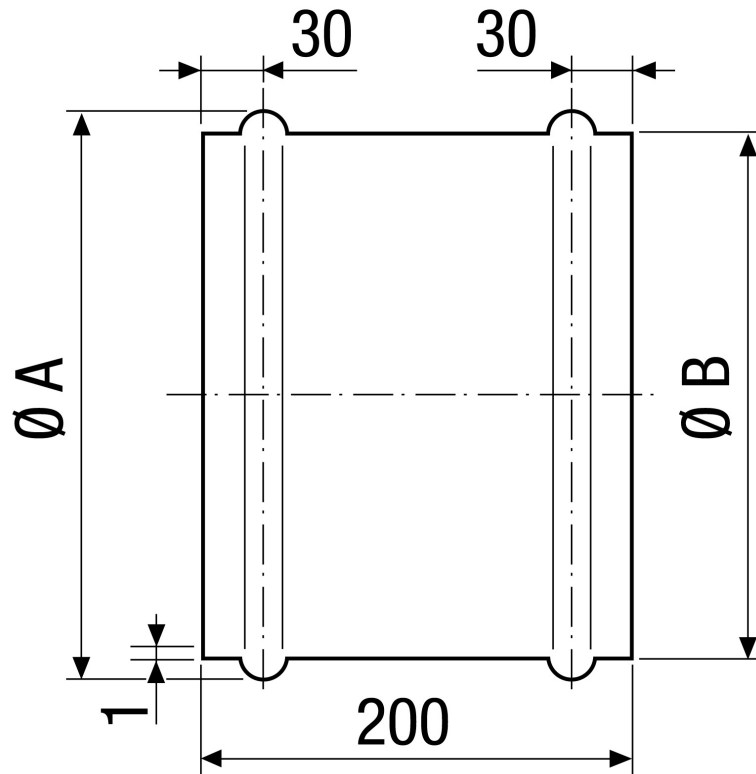

A	B
376	369