

VH 40



Short description

Sheet steel wall sleeves, for fans with the nominal size 400

Article number 0055.0034

Technical data

Installation site	Wall / Ceiling
Material	Sheet steel, galvanised
Weight	2,06 kg
Weight including packaging	2,1 kg
Suitable for nominal size	400 mm
Width	426 mm
Height	426 mm
Depth	200 mm
Width with packaging	426 mm
Height with packaging	426 mm
Depth with packaging	200 mm
Packing unit	1 piece
Range	C
GTIN (EAN)	4012799550341

VH 40

Dimensioned drawing [mm]

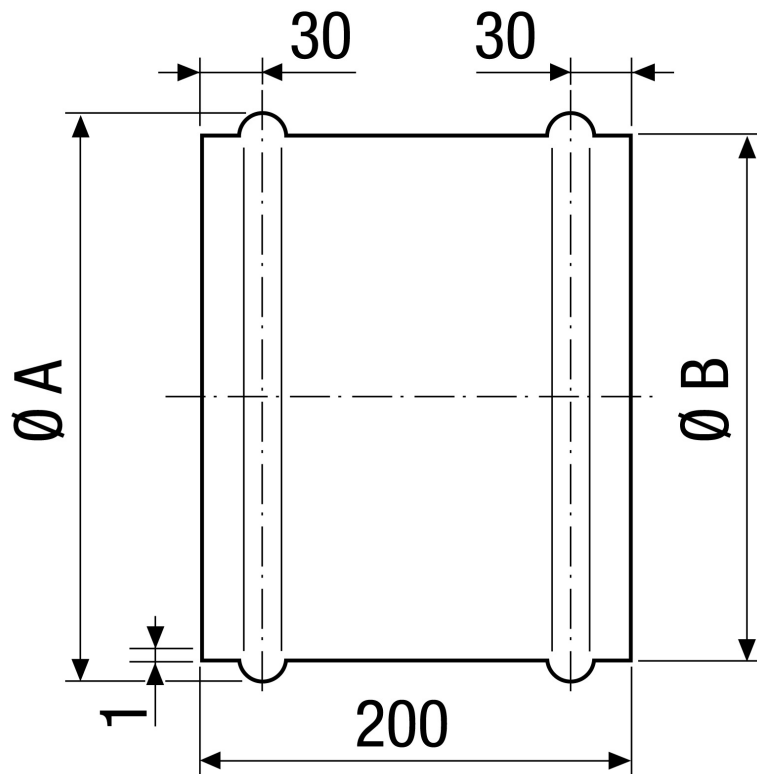

A	B
426	419