

VH 45



Short description

Sheet steel wall sleeves, for fans with the nominal size 450

Article number 0055.0036

Technical data

Installation site	Wall / Ceiling
Material	Sheet steel, galvanised
Weight	2,3 kg
Weight including packaging	2,3 kg
Suitable for nominal size	450 mm
Width	471 mm
Height	471 mm
Depth	200 mm
Width with packaging	471 mm
Height with packaging	471 mm
Depth with packaging	200 mm
Packing unit	1 piece
Range	C
GTIN (EAN)	4012799550365

VH 45

Dimensioned drawing [mm]

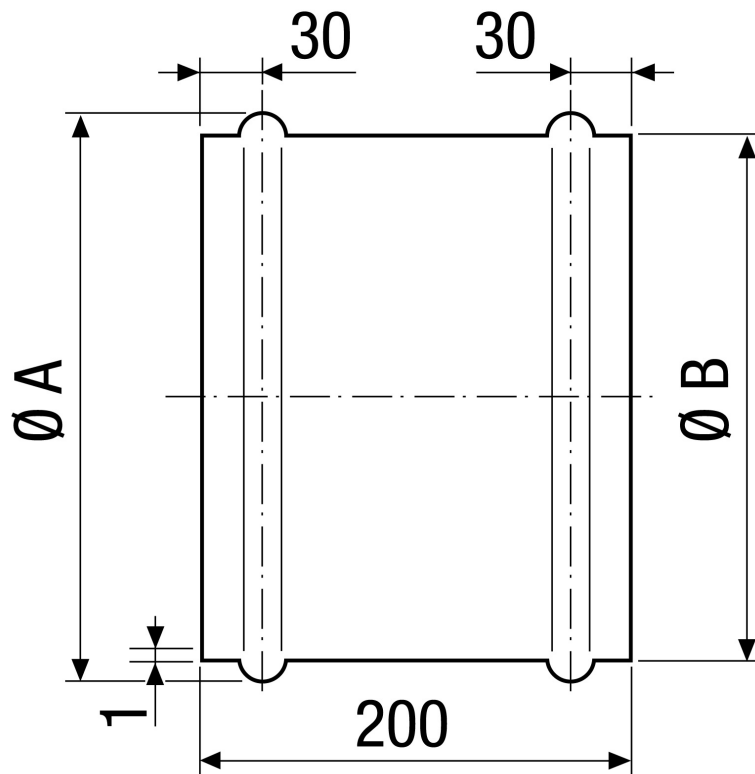

A	B
471	467