

# VH 50



## Short description

Sheet steel wall sleeves, for fans with the nominal size 500

Article number 0055.0035

## Technical data

Installation site	Wall / Ceiling
Material	Sheet steel, galvanised
Weight	2,5 kg
Weight including packaging	2,52 kg
Suitable for nominal size	500 mm
Width	526 mm
Height	526 mm
Depth	200 mm
Width with packaging	526 mm
Height with packaging	526 mm
Depth with packaging	200 mm
Packing unit	1 piece
Range	C
GTIN (EAN)	4012799550358

# VH 50

Dimensioned drawing [mm]

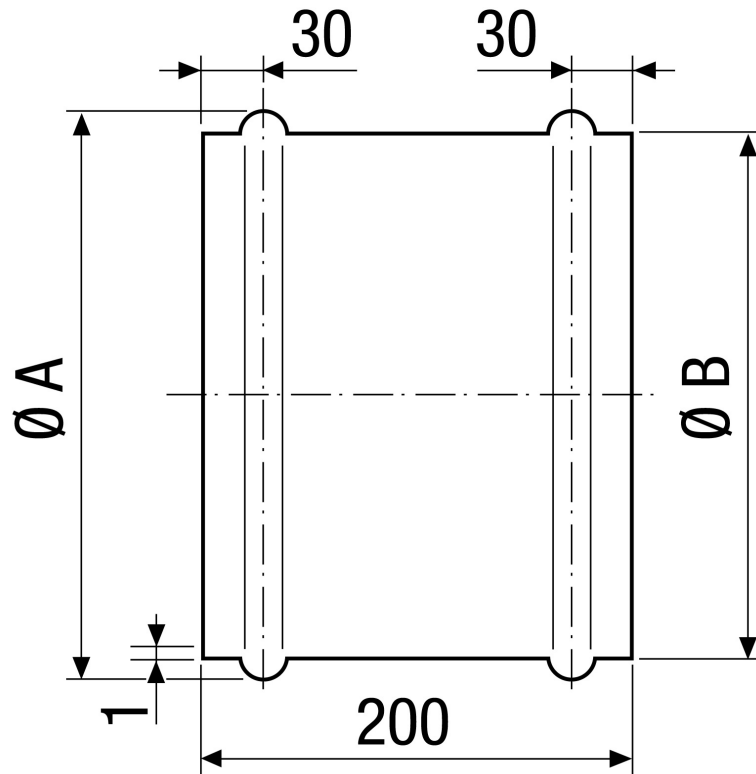

A	B
526	522