

DPK 25/6 B

Ceiling installation in industrial buildings

- Insert ELP flexible coupling in order to prevent transfer of vibration onto the duct system to the fan suction and pressure side.
- Airstream and rotational direction are marked by arrows on the housing.
- Mounting components must be supplied by the customer.

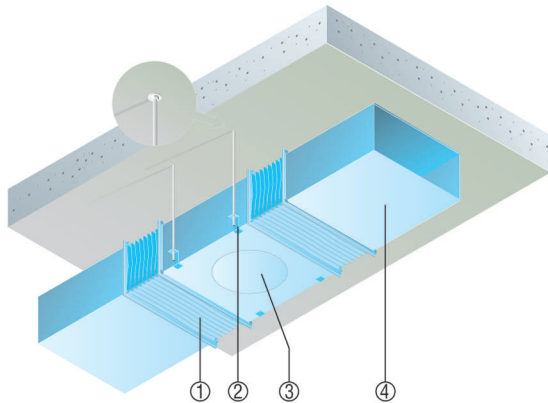

- ① ELP flexible coupling
- ② Mounting component, to be supplied by the customer
- ③ EPK, DPK fan
- ④ Ventilation channel, to be supplied by the customer

Ventilation and air extraction of large kitchen using channel fan and kitchen exhaust air box

- In situations where there is little space available for the ventilation system, the DPK EC and DSK EC (sound-insulated) duct fans are ideal for installing in suspended ceilings, for example. Its low mounting height means that it fits easily in suspended ceilings. This allows the ventilation ducts to be fitted with ease.
- And the EKR-2 kitchen exhaust air box is the right choice of fan for places where hot and greasy air needs extracting from large kitchens in commerce or schools. The external motor, which is therefore not in the air flow, is not sensitive to hot, greasy or contaminated air flows.
- In the example shown, a channel fan is supplying a kitchen with supply air.
- Air filter, sound absorber and electric air heater round off the supply air pipe. The supply air is blown in close to the ceiling and spread throughout the room.
- The exhaust air is extracted by range hoods above the cooking areas. The air inlets and air outlets are distributed such that the room receives optimum cross-ventilation. The EKR-2 kitchen exhaust air box then removes the outgoing air outdoors via a duct system. The volume of air extracted by the kitchen exhaust air box can be set using a control unit as necessary.

INSTALLATION INSTRUCTIONS

DPK 25/6 B

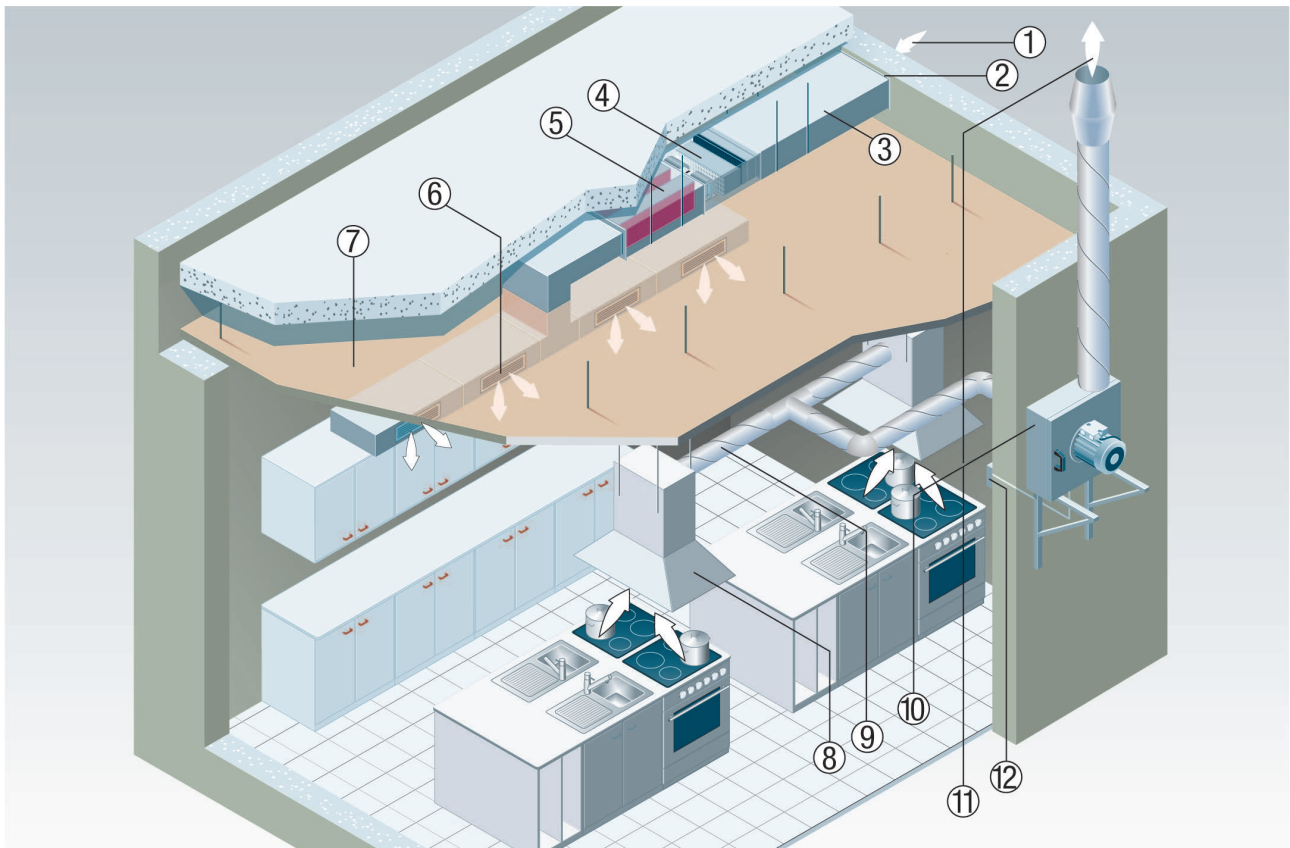

- ① Outside air
- ② External grille
- ③ Channel system supply air
- ④ Channel fan DPK EC / DSK EC (sound-insulated)
- ⑤ KSP channel sound insulation
- ⑥ Supply air opening
- ⑦ suspended ceiling
- ⑧ range hood
- ⑨ Channel system exhaust air
- ⑩ EKR-2 kitchen exhaust air box
- ⑪ Exhaust air
- ⑫ Control for supply and exhaust air
- ⑬ Mounting components for assembly to ceiling, to be supplied by the customer
- ⑭ Ventilation channel, to be supplied by the customer

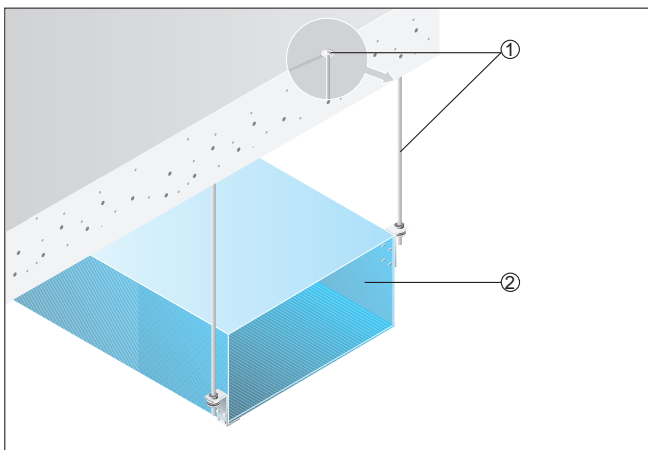

DPK 25/6 B

Installation example

The illustrations show a rectangular ventilation channel with different mounting positions. Mounting components and material must be provided by the customer.

① Mounting components for lateral mounting, to be provided by the customer

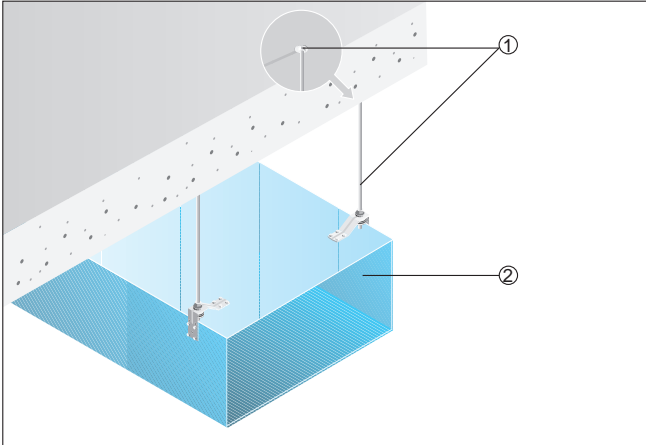

① Ventilation channel, to be supplied by the customer

Combination with a heat exchanger

The heat exchanger can be mounted in any position. The installation position is based on the location. A horizontal installation position is recommended for assembly in suspended ceilings.

Mount the heat exchanger tilted towards the condensation outflow. The condensation outflow is supplied in a plastic bag that is taped to the housing.

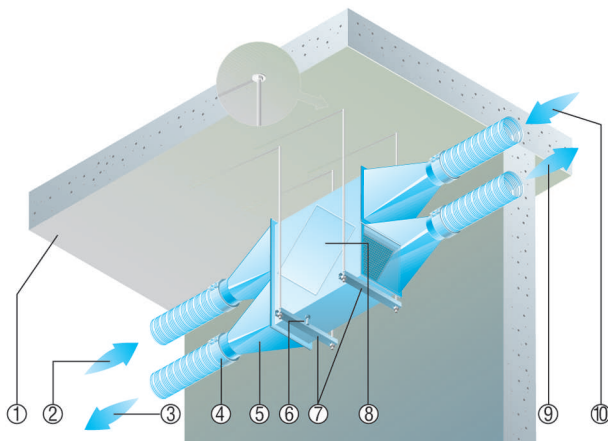

- ① Building ceiling
- ② Outside air
- ③ Outgoing air
- ④ Duct fixing cuffs
- ⑤ Adaptors, to be supplied by the customer
- ⑥ Condensation outflow
- ⑦ Mounting components, to be supplied by the customer
- ⑧ Heat exchanger
- ⑨ Supply air
- ⑩ Exhaust air