

DRD 18/2 B

Installation on flat roof

- The roof fan is fitted on a flat roof in the example shown.
- Note how it is combined with a tubular sound absorber (e.g. RSR). The combination with a tubular sound absorber is the typical installation situation.

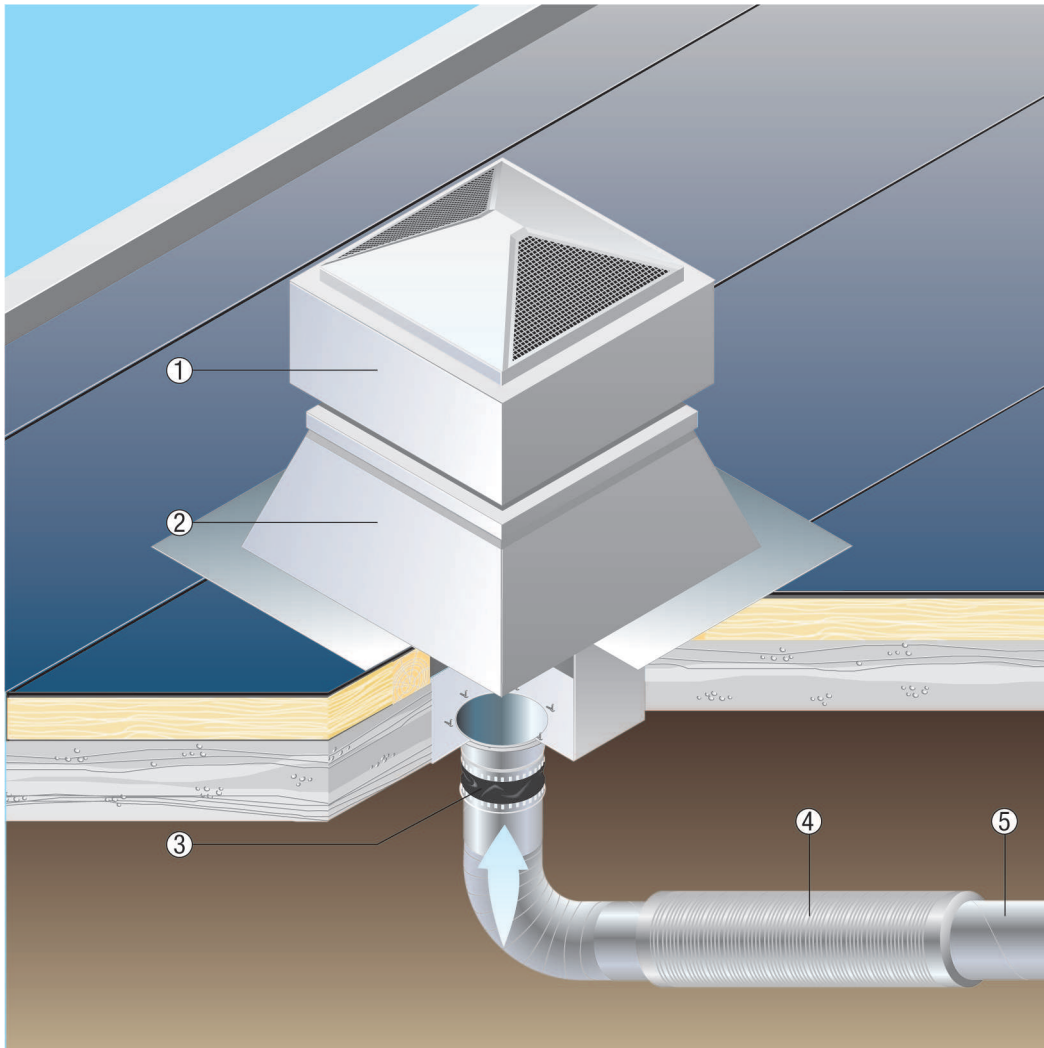

- ① Centrifugal roof fan
- ② Roof socket
- ③ Flexible coupling
- ④ Tubular sound absorber
- ⑤ Ventilation duct, to be provided by the customer

Tile roofs

- The SDS pitched roof socket is specially manufactured for mounting on tiled roofs.
- The type of roof tiles and roof pitch must be given at the time of ordering.

INSTALLATION INSTRUCTIONS

DRD 18/2 B

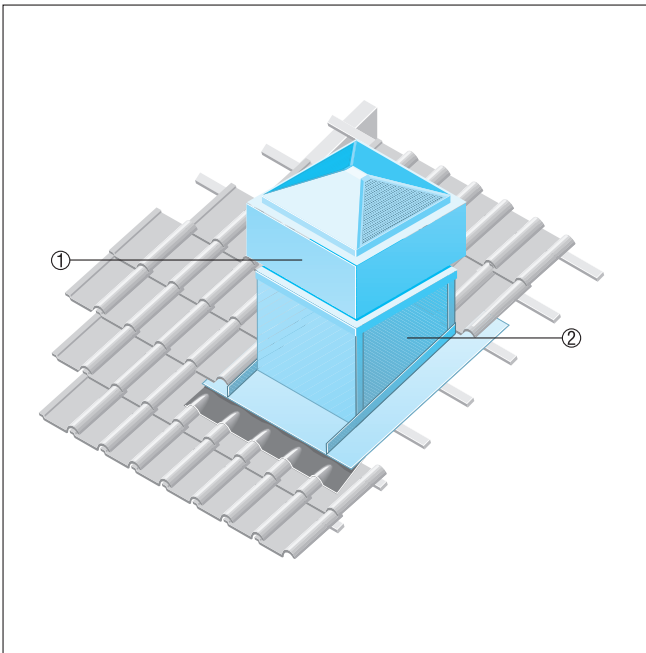

- ① ERD, DRD centrifugal roof fan
- ② SDS pitched roof socket

Installation on tiled roof

- The roof fan is fitted on a tiled roof in the example shown.
- Note how it is combined with an exhaust air silencer (e.g. SDA). This variant is recommended if the noise from the roof fan is not to disturb its surroundings.

DRD 18/2 B



- ① Exhaust air silencer
- ② Centrifugal roof fan
- ③ Roof socket
- ④ Ventilation duct, to be supplied by the customer
- ⑤ Tubular sound absorber

Corrugated or trapezoidal roofs

- The SOWT corrugated and trapezoidal roof socket is suitable for use with all types of trapezoidal and corrugated roofs.
- The roof pitch must be given at the time of ordering.

DRD 18/2 B

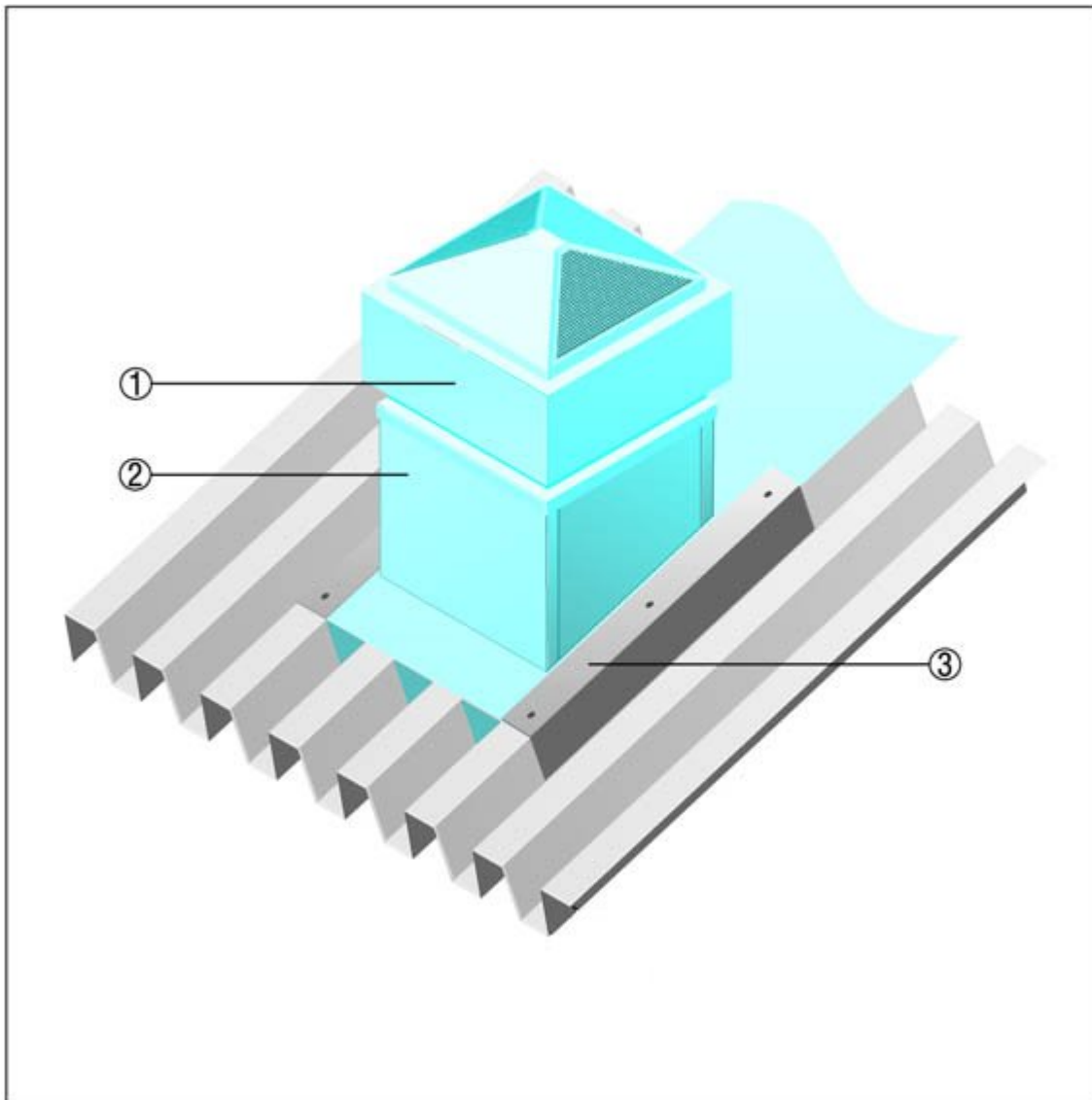

- ① ERD and/or DRD centrifugal roof fan
- ② SOWT corrugated and trapezoidal roof socket
- ③ Roof-mounted connector, to be supplied by the customer

Roof fans for centralised air extraction

- With centralised air extraction, several apartments and rooms are connected to one shared main duct.
- A central exhaust air duct runs vertically through the entire building.
- One centralised fan on the roof or in the main duct displaces the stale air outside via the exhaust air elements in the bathroom and kitchen. Outside air flows into the apartment draft-free via supply air elements.
- In addition to all the benefits of controlled domestic air ventilation, a centralised air ventilation system also has other benefits such as:
 - Health and hygiene thanks to continuous ventilation
 - Quieter than individual room fans
 - Dehumidification and maintenance of basic structure of building
 - Air is automatically extracted from empty apartments
 - Automatic air extraction of all neighbouring apartments - user cannot intervene

INSTALLATION INSTRUCTIONS

DRD 18/2 B

- Systems engineering accessible at all times - no need to access neighbouring apartments.

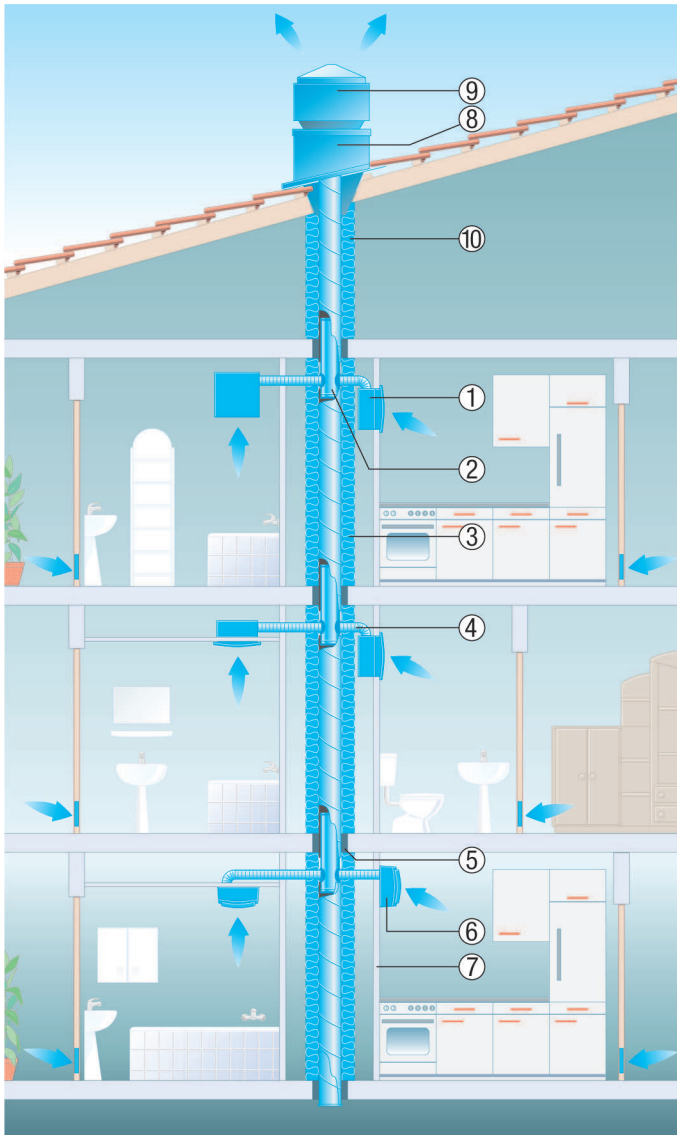

- ① Centro exhaust air element, ER-UPD recessed-mounted housing for fitting inside or outside the shaft.
- ② BA fire protection compensation element
- ③ BI fire protection insulation
- ④ SFR flexible steel duct
- ⑤ Ceiling compound, at least 100 mm thick
- ⑥ Centro APB exhaust air element for fitting on or outside the shaft.
- ⑦ Shaft wall made from plaster board (plaster board at least 12.5 mm thick in class A2 according to DIN 4102)
- ⑧ SDS roof socket
- ⑨ ERD roof fan or GRD roof fan with EC motor
- ⑩ Insulation (fire protection + preventing the formation of condensation)

Flat roofs

- With SD socket sound absorber for sound insulation on intake side.

INSTALLATION INSTRUCTIONS

DRD 18/2 B

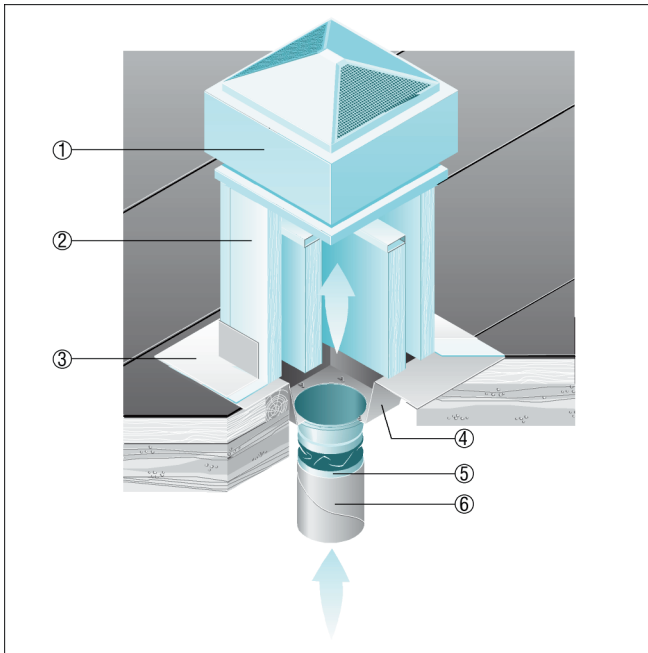

- ① ERD, DRD centrifugal roof fan
- ② SD socket sound absorber
- ③ Roof-mounted connector, to be supplied by the customer
- ④ SZ intermediate sockets
- ⑤ ELA flexible coupling
- ⑥ Ventilation duct, to be supplied by the customer