

DZF 40/6 B

Supply and exhaust air for sensitive systems where the outside air is polluted

- Reliable ventilation and air extraction in systems with tougher ventilation requirements (e.g. electric or electronic switching systems) can be provided with a combination of EZF/DZF fans for wall installation and EZQ/DZQ wall-mounted fans.
- EZF/DZF fans for wall installation and a RS shutter provide the supply air. Fitting the ZFF air filter is the recommended approach if the outside air is very polluted (e.g. building site, on roads or railway tracks).
- An EZQ/DZQ wall-mounted fan with corresponding AS shutter blows the exhaust air out.

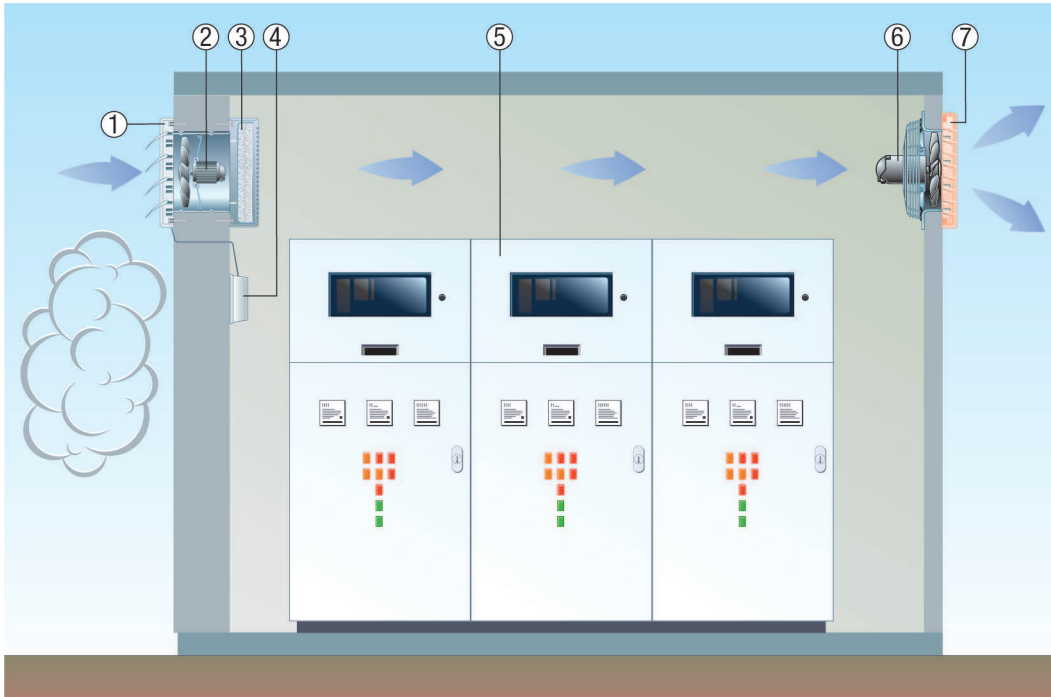

- ① RS shutter
- ② EZF/DZF wall-mounted fan
- ③ ZFF air filter
- ④ Servomotor
- ⑤ Electric or electronic switching systems
- ⑥ EZQ/DZQ wall-mounted fan
- ⑦ AS shutter

Wall installation

- Lightly press the fan wall sleeve to insert it into the extension sleeve.
- Insert the fan into the wall together with the extension sleeve
- Fill the gap between the extension sleeve and the external wall with plaster or add another extension sleeve of a suitable length
- Please note: Do not install the extension sleeve on the fan side flush with the plaster, as then the fan cannot be mounted on the wall.

INSTALLATION INSTRUCTIONS

DZF 40/6 B

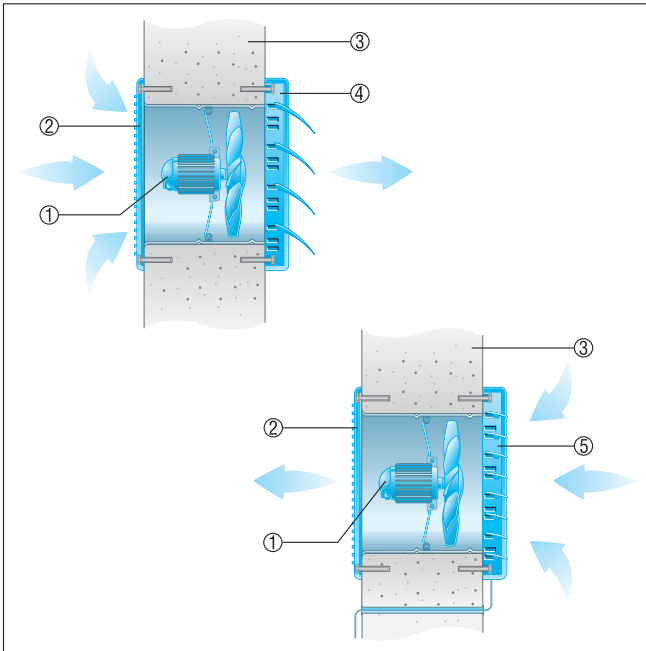

- ① EZF fan
- ② Internal grille
- ③ External wall
- ④ AS shutter, airstream-operated opening and closing.
- ⑤ RS shutter, electrically or manually operated.

Wall installation with filter

■ To ensure trouble-free functioning of the ZFF filter, clean or replace the filter mat at regular intervals.

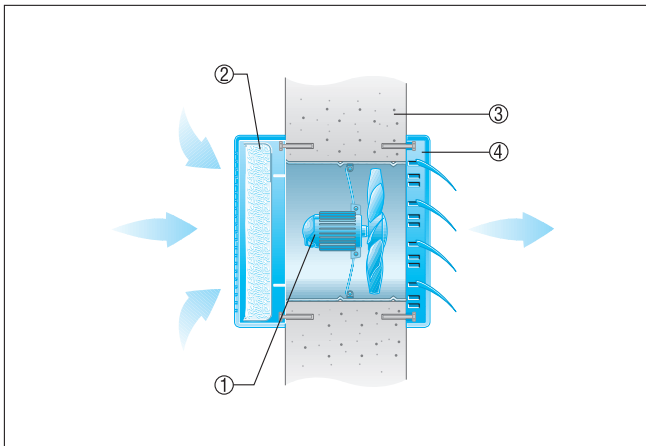

- ① EZF fan
- ② ZFF filter
- ③ External wall
- ④ AS shutter, airstream-operated opening and closing