

## DZQ 40/6 B

### Air extraction from server / compressor / transformer rooms

- The EZQ/EZS or DZQ/DZS wall-mounted fans can be used to extract air and therefore remove high thermal loads from closed rooms.
- A thermostat (e.g. TH 16) permanently measures the room temperature.
- If the setpoint temperature is exceeded, firstly the exhaust fan (e.g. EZQ/EZS or DZQ/DZS) switches on and secondly the shutter, e.g. MK opens.
- The fan extracts the warm exhaust air from near the ceiling.
- Cool supply air flows to ground level through the open shutters.
- For optimum operation with minimum flow resistance, the free cross-section area for supply air should be twice that for exhaust air.
- A supply air filter (e.g. ZFF) collects particles of dust and dirt from the supply air to protect sensitive electric or electronic systems in the room from damage.

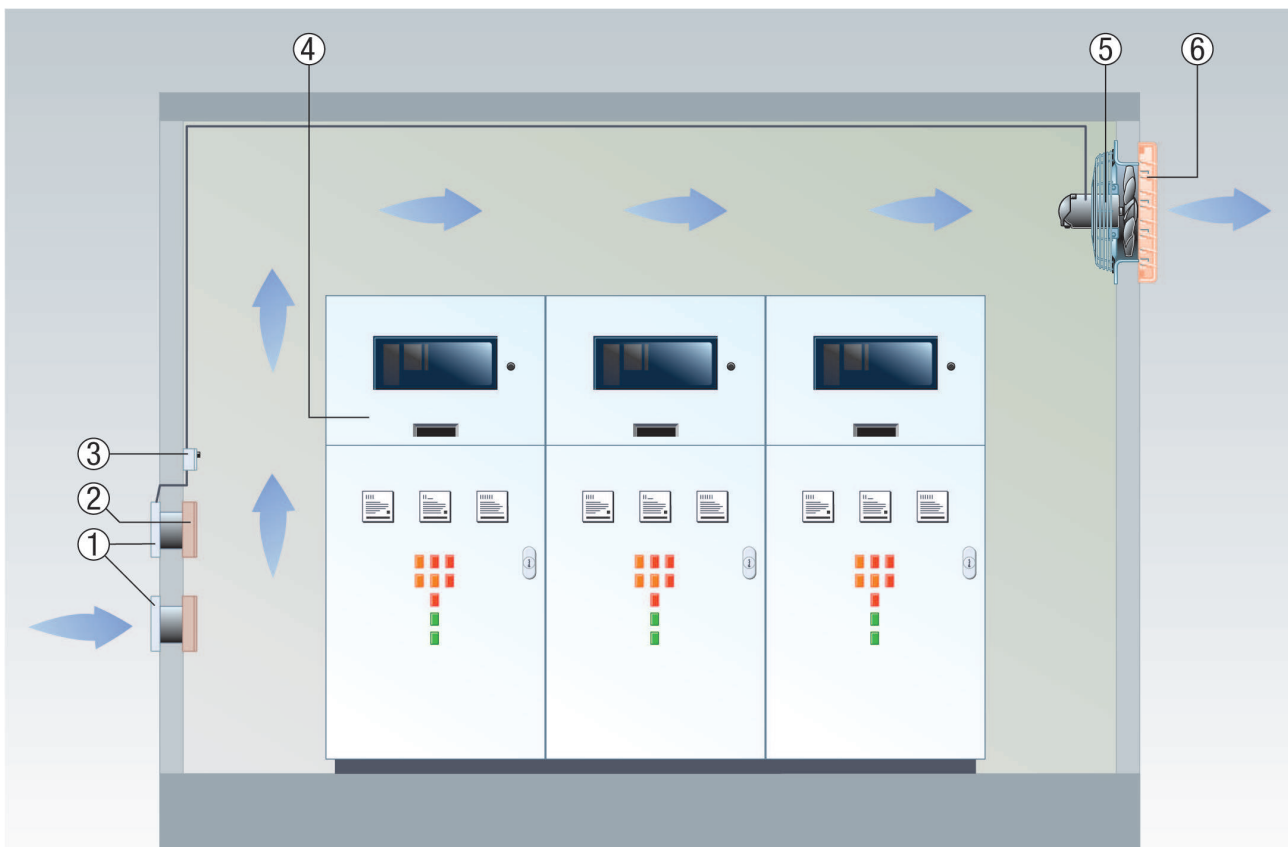

- ① MK, BK shutter
- ② ZFF air filter
- ③ TH 10, TH 16 thermostat
- ④ Systems with high thermal load
- ⑤ EZQ/EZS or DZQ/DZS fan
- ⑥ RS external shutter

### Air extraction in storage rooms

With cross-ventilation, the supply air flows through the whole room before being extracted again.

In most cases the supply air opening (e.g. MLA or MLZ external grille) should be fitted near the ground. However extract the exhaust air from near the ceiling using a wall-mounted fan (e.g. EZQ or DZQ).

# INSTALLATION INSTRUCTIONS

## DZQ 40/6 B

This setup does not apply if gases which are heavier than air (e.g. CO<sub>2</sub> or most combustible gases and vapours from a potentially explosive atmosphere) are to be extracted. Then the supply air should be fitted under the ceiling and the exhaust air extracted from ground level.

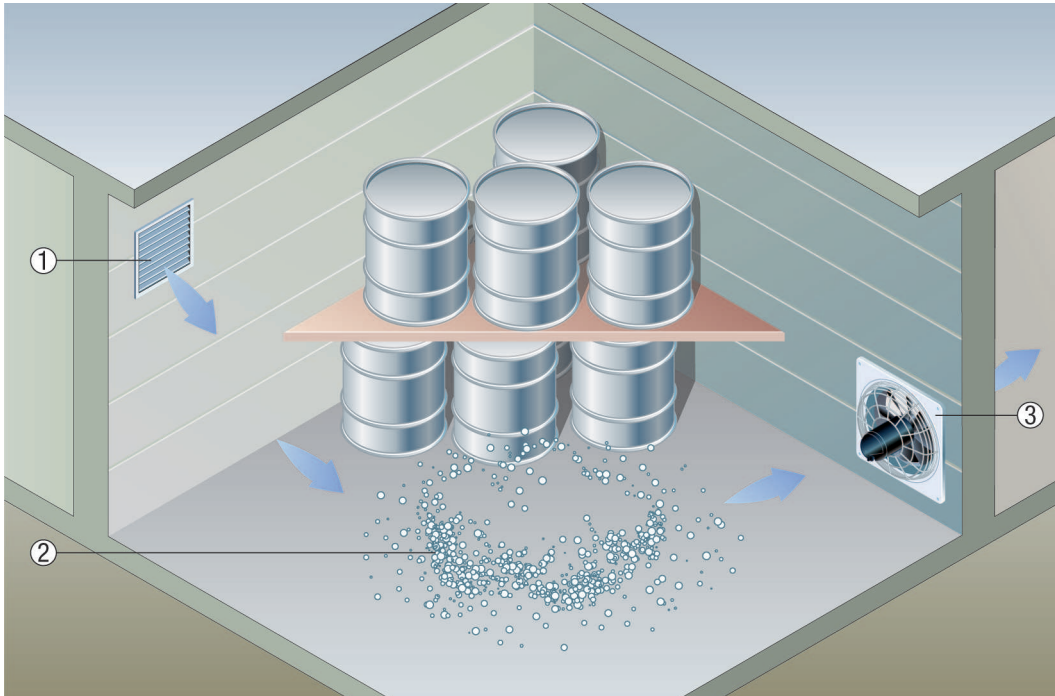

- ① MLA or MLZ external grille
- ② EZQ or DZQ fan

### Supply and exhaust air for sensitive systems where the outside air is polluted

- Reliable ventilation and air extraction in systems with tougher ventilation requirements (e.g. electric or electronic switching systems) can be provided with a combination of EZF/DZF fans for wall installation and EZQ/DZQ wall-mounted fans.
- EZF/DZF fans for wall installation and a RS shutter provide the supply air. Fitting the ZFF air filter is the recommended approach if the outside air is very polluted (e.g. building site, on roads or railway tracks).
- An EZQ/DZQ wall-mounted fan with corresponding AS shutter blows the exhaust air out.

## DZQ 40/6 B

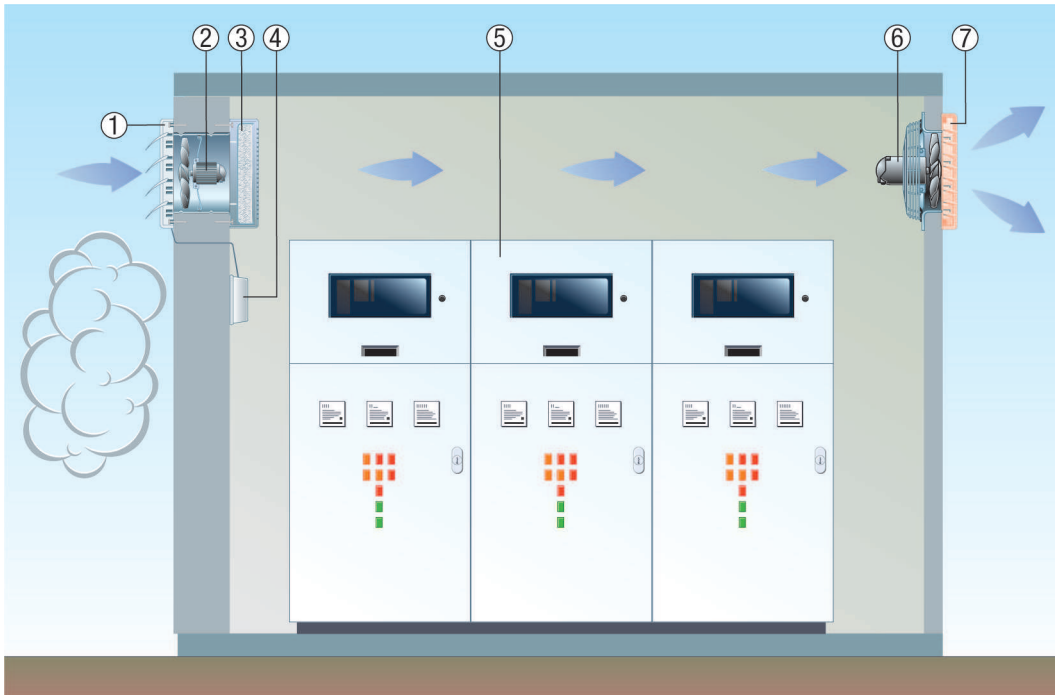

- ① RS shutter
- ② EZF/DZF wall-mounted fan
- ③ ZFF air filter
- ④ Servomotor
- ⑤ Electric or electronic switching systems
- ⑥ EZQ/DZQ wall-mounted fan
- ⑦ AS shutter

### Wall installation with extension sleeve

- Insert the conical wall mounting ring of the fan into the VH extension sleeve using light pressure.
- Insert the fan into the wall together with the extension sleeve.
- Fill the gap between the extension sleeve and the external wall with plaster or add another extension sleeve of a suitable length.
- Notice: Do not install the extension sleeve on the fan side flush with the plaster, as then the fan cannot be mounted on the wall.

# INSTALLATION INSTRUCTIONS

## DZQ 40/6 B

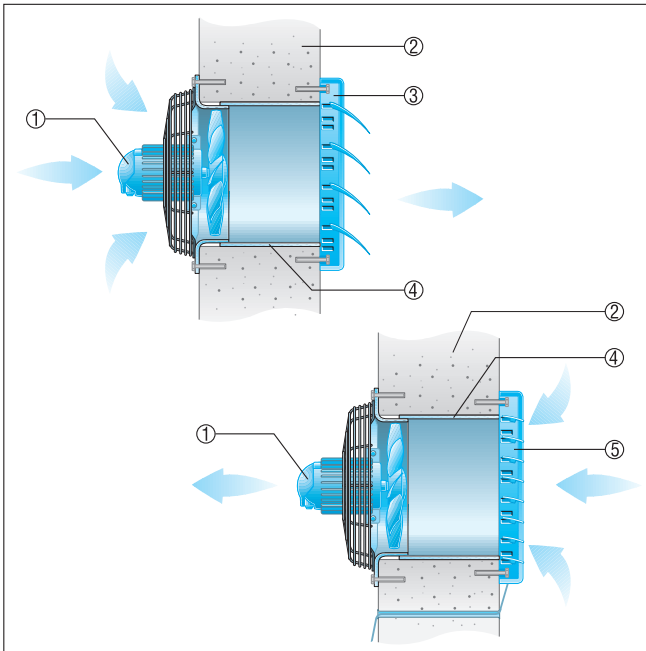

- ① Fan
- ② External wall
- ③ AS shutter, airstream-operated
- ④ VH extension sleeve
- ⑤ RS shutter, electrically or manually operated

### Installation in thin walls

■ Use a connection frame; see Recommended Accessories: The fan is fastened using the supplied fixing brackets

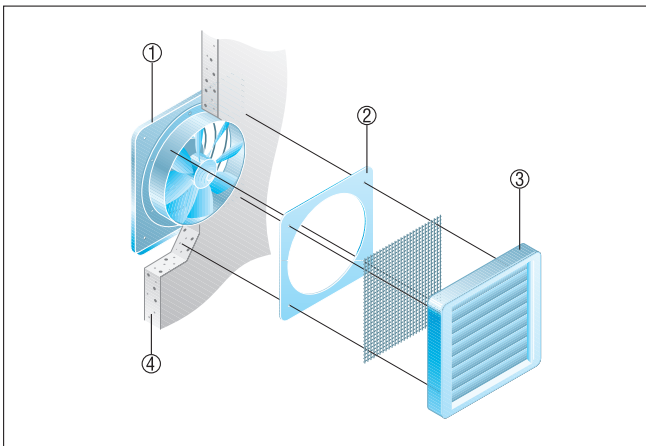

- ① Fan
- ② Connection frame
- ③ Shutter, airstream-operated
- ④ External wall