

DZR 20/2 B

EZR/DZR - installation in ventilation duct

- The diagram shows a typical installation situation for EZR/DZR duct fans. The fans are integrated into the ducting using flexible couplings.
- Recommended distance to the next element is a minimum of 3 - 5 x the duct diameter.
- If the cross-section narrows: small duct diameter <math>< 0.75 \times</math> large duct diameter, angle of inclination 6-8°.

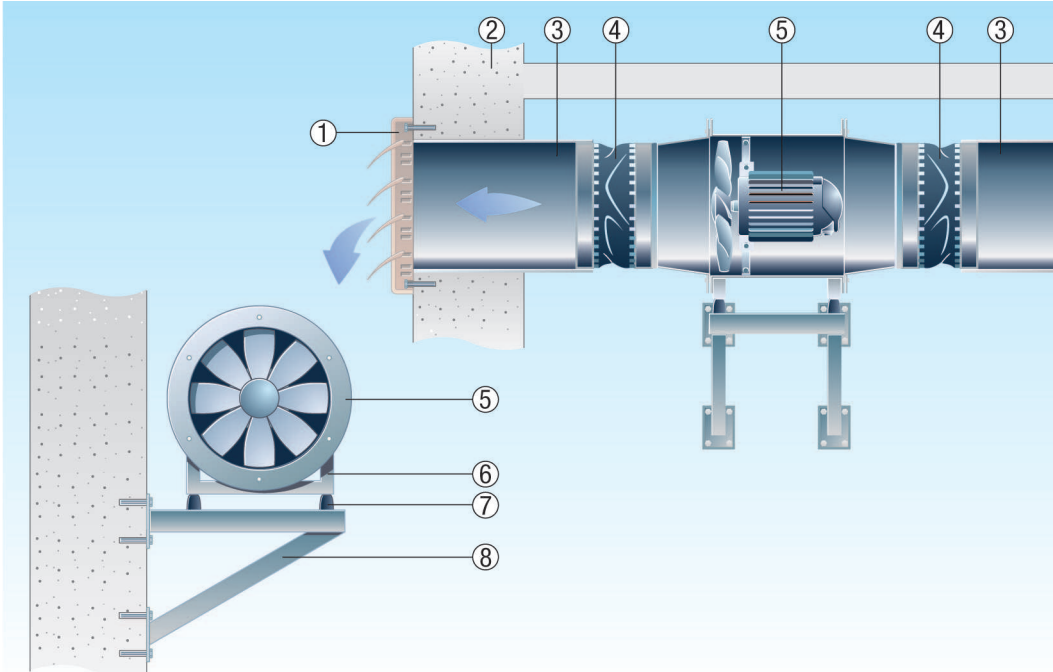

- ① External shutter, airstream operated
- ② Outside wall
- ③ Ventilation duct, to be supplied by the customer
- ④ Flexible coupling
- ⑤ Fan
- ⑥ Mounting feet
- ⑦ Vibration damper
- ⑧ Bracket, to be supplied by the customer