

DZS 50/4 B Ex e

Wall fans for air extraction

- Air extraction can prevent the formation of a potentially explosive atmosphere from combustible fluids.
- To achieve this, the air/gas mix is extracted from the point at which it is produced using EZQ ... E Ex or DZQ ... Ex extract-ed.

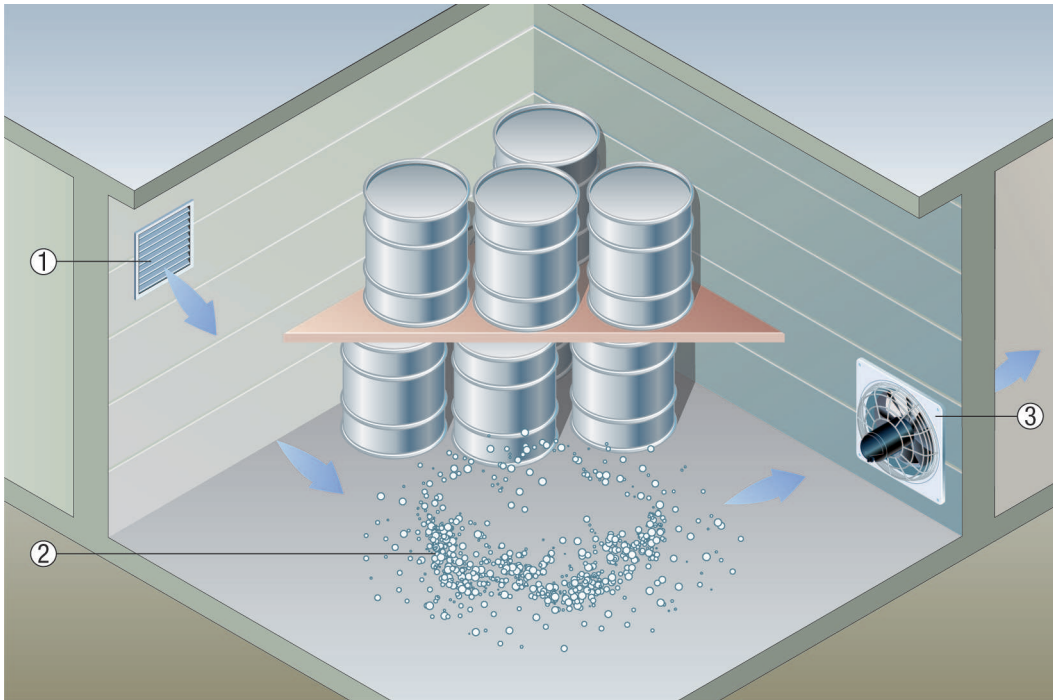

- ① MLA or MLZ external grille
- ② Explosive atmosphere
- ③ Fan EZQ ... E Ex or DZQ ... Ex

Cross-ventilation in battery rooms

- As the cells are charged, hydrogen is produced in the battery rooms and collects under the ceiling. With lead batteries, sulphuric acid mist forms close to the ground at the same time. Both must be extracted.
- Equip the air extraction system with exhaust air openings at floor and ceiling height for this purpose. Or extract the exhaust air directly with EZQ ... E Ex or DZQ ... Ex wall fans.
- Supply air is fed in at the opposite end of the battery room using a separate ventilation system. If possible, the simplest solution is to use EZQ ... E Ex or DZQ ... Ex wall fans to blow in outside air.

INSTALLATION INSTRUCTIONS

DZS 50/4 B Ex e

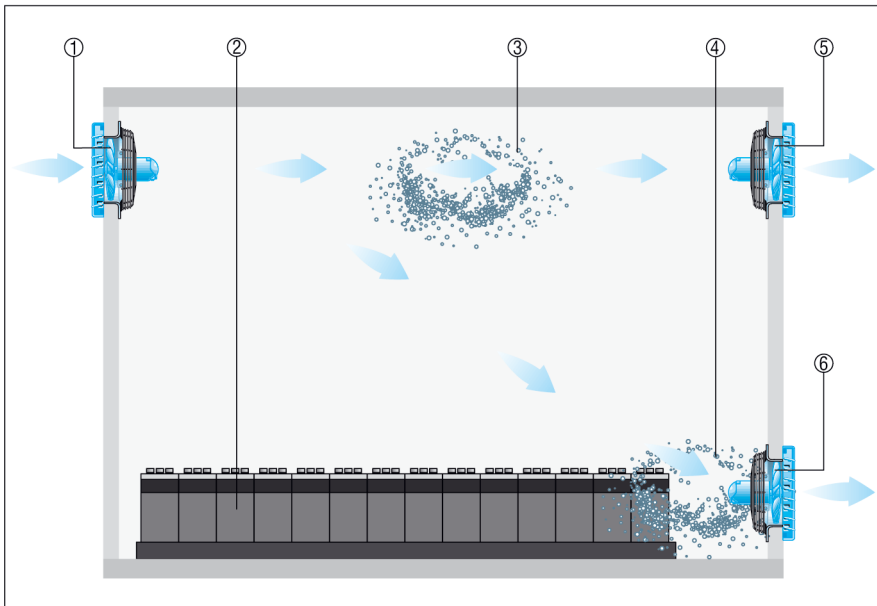

- ① EZQ 20 E Ex / DZQ ... Ex supply air fan
- ② Batteries in charging station
- ③ Explosive atmosphere (hydrogen)
- ④ Sulphuric acid mist
- ⑤ EZQ 20 E Ex / DZQ ... exhaust air fan Ex for extracting the hydrogen
- ⑥ EZQ 20 E Ex / DZQ ... exhaust air fan Ex for extracting the sulphuric acid mist

Wall installation with extension sleeve

- Place the conical nozzle wall ring of the fan with slight pressure into the VH extension sleeve.
- Insert the fan, together with the extension sleeve, into the wall.
- Plaster the distance between the extension sleeve and the exterior wall or install another extension sleeve of a suitable length.
- Notice: Do not insert the extension sleeve on the fan side flush with the plaster; then it isn't possible to fix the fan to the wall.

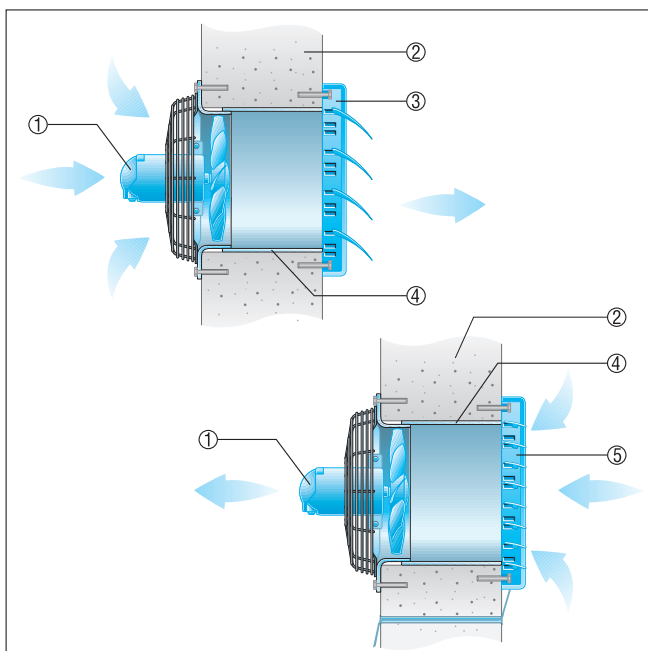

INSTALLATION INSTRUCTIONS

DZS 50/4 B Ex e

- ① Fan
- ② Exterior wall
- ③ AS shutter, airstream-operated
- ④ VH extension sleeve
- ⑤ RS shutter, electrically or manually operated

Installation in thin walls

■ Spacing frames, see recommended accessories: The attachment to the fan is done with the enclosed fixing brackets.

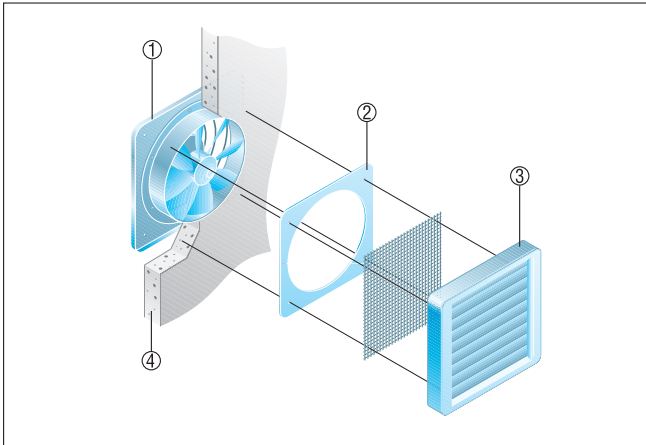

- ① Fan
- ② Spacing frames
- ③ AS shutter, airstream-operated
- ④ Exterior wall