

EN 31

Wall-mounted fans for ventilation of and air extraction from day rooms

- The right ventilation and air extraction plays a key role in all day rooms: restaurants, canteens, staff rooms, waiting rooms, changing rooms, takeaways, etc..
- There the air quality is polluted by odours, increased air humidity and a lack of oxygen. A suitable ventilation should include consideration of the following:
 - Air volumes of supply and exhaust fans of the same sizes.
 - Consider cross-ventilation so that the air is actually replaced.
 - As of a volumetric flow of around 600 m³/h, the supply air should be heated.

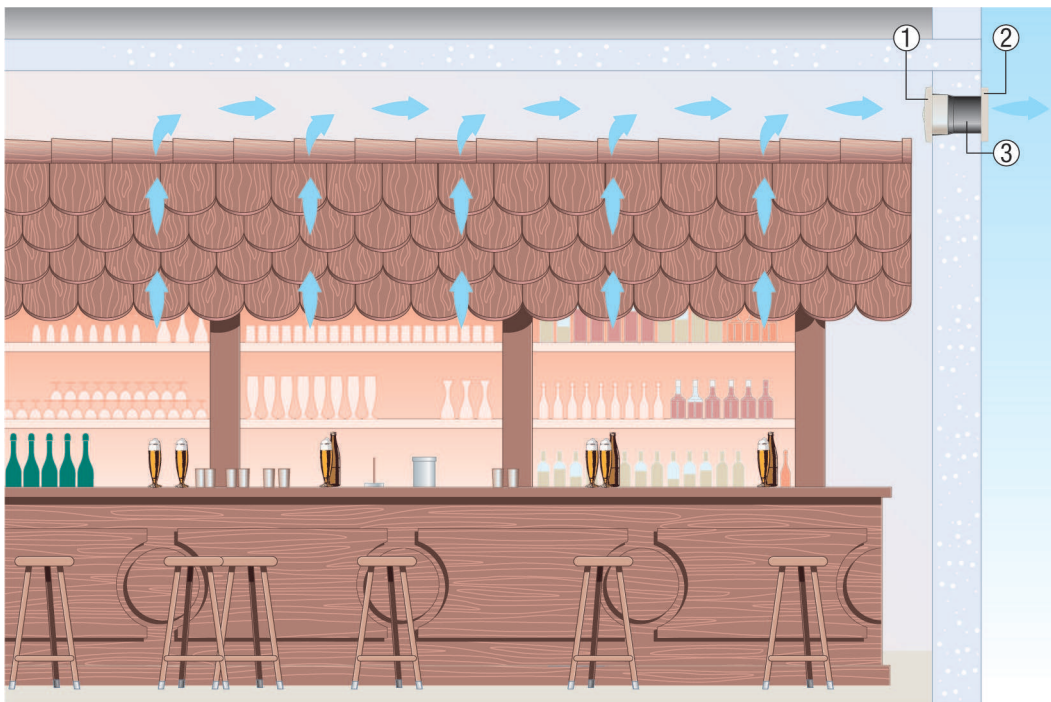

- ① EN, ENR wall-mounted fan
- ② External shutter
- ③ WH wall sleeve

Wall installation

Take the following instructions into account when mounting EN or ENR series wall fans:

- Provide sufficient fresh air during fan operation.
- Only operate the fan if protection against accidental contact with the impeller on the external wall side is guaranteed to be in accordance with DIN EN ISO 13857 (DIN 31001), e.g. AS, RS, BK or MK series shutters.
- Use WH 20, WH 25 or WH 31 wall sleeves for walls up to 280 mm.
- Use VH extension sleeves for thicker walls.
- BK or MK shutters prevent entry of cold air when the fan is switched off.

INSTALLATION INSTRUCTIONS

EN 31

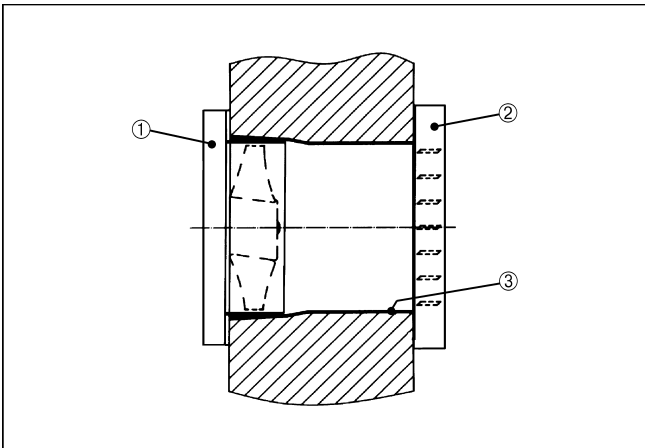

- ① EN, ENR fan
- ② BK or MK electrical shutter
- ③ EN-WH Wall sleeve