

ERM 25 Ex e/60 Hz

ERM ... Ex e for air extraction from storage rooms with explosive atmospheres

- MAICO fans can be used to bring the concentration of combustible gases under the explosion limit. This reliably prevents the formation of an explosive atmosphere.
- In the example shown, an ERM ... fan extracts Ex e gases, that are heavier than air. It is therefore positioned close to the ground.

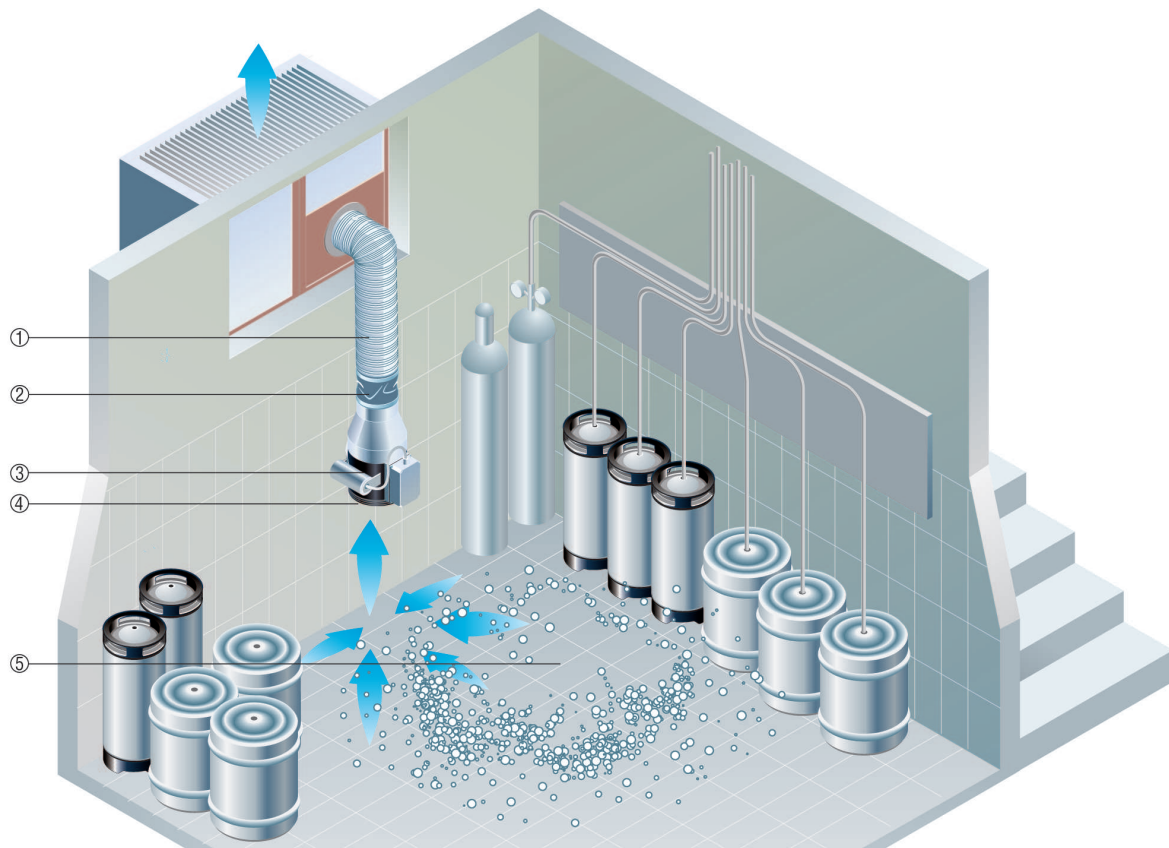

- ① Ventilation duct, to be provided by the customer
- ② ELM ... fixing cuff Ex
- ③ Fan ERM ... Ex e
- ④ SGM ... protective grille Ex
- ⑤ Explosive atmosphere

ERM ... E Ex e for the ventilation of storage rooms with explosive atmospheres

MAICO fans can be used to bring the concentration of combustible gases under the explosion limit. This prevents the build-up of an explosive atmosphere. In the example shown, an ERM ... E EX e fan extracts gasses that are heavier than air. This is why the fan is installed close to the ground.

INSTALLATION INSTRUCTIONS

ERM 25 Ex e/60 Hz

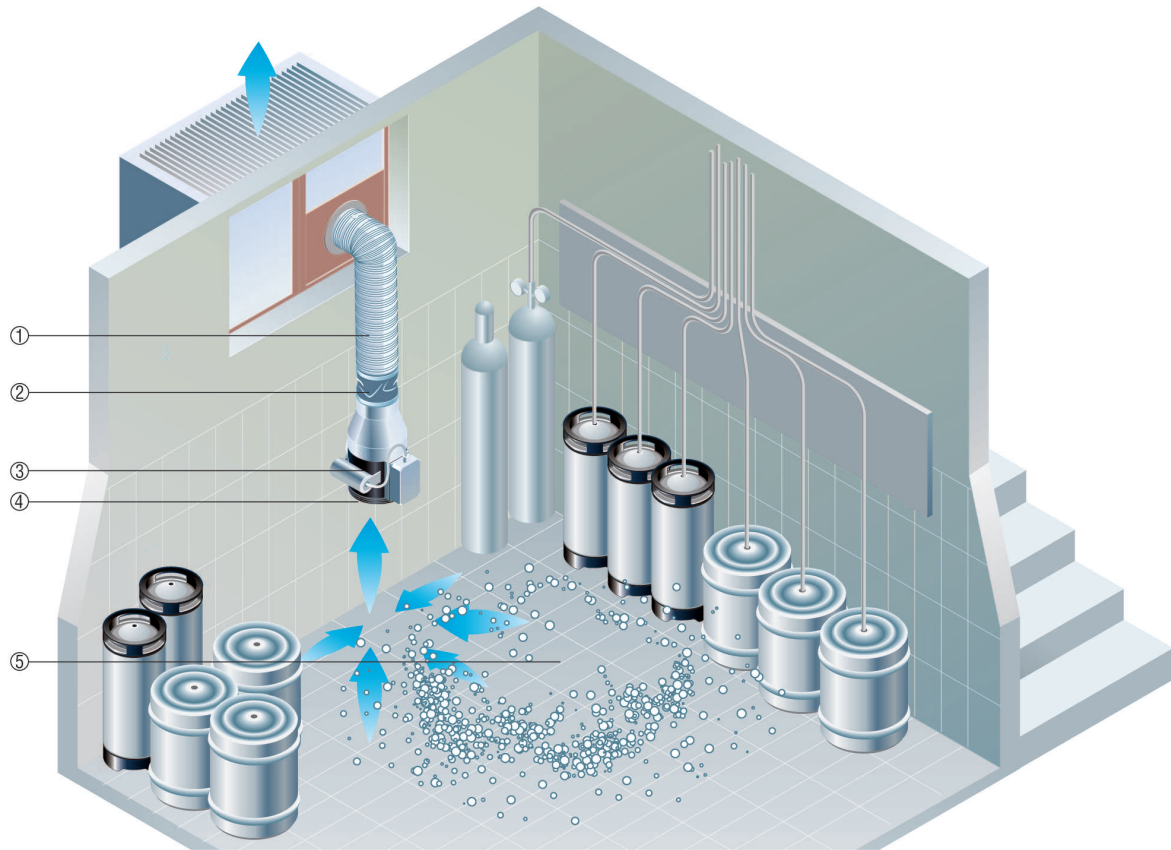

- ① Ventilation duct, to be supplied by the customer
- ② ELM ... Ex Fixing cuff
- ③ ERM ... E Ex e fan
- ④ SGM ... Ex Protective grille
- ⑤ Potentially explosive atmosphere

Installation in ventilation ducts

- The illustration shows the installation of an ERM-Ex fan within a duct system.
- Use FUM foot to fix the fan to the wall or ceiling. The mounting foot can be fixed to the fan circumference, in any position, using the tapping screws provided.

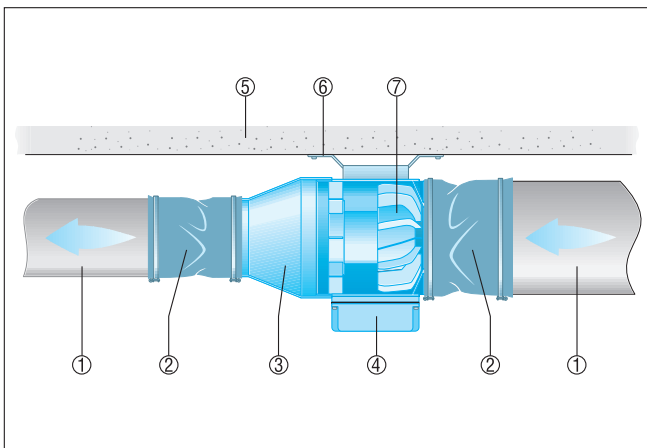

- ① Ventilation duct, to be provided by the customer
- ② ELM-Ex flexible cuffs
- ③ REM-Ex reducer

INSTALLATION INSTRUCTIONS

ERM 25 Ex e/60 Hz

- ④ Terminal box
- ⑤ Ceiling, girder
- ⑥ FUM mounting foot
- ⑦ ERM-Ex fan

Installation at the end of the line, free fan inlet

- The illustration shows the installation of an ERM-Ex fan at the end of a duct system.
- Use FUM foot to fix the fan to the wall or ceiling. The mounting foot can be fixed to the fan circumference, in any position, using the tapping screws provided.
- In case of free air outlet, use protective grille SGM-Ex.

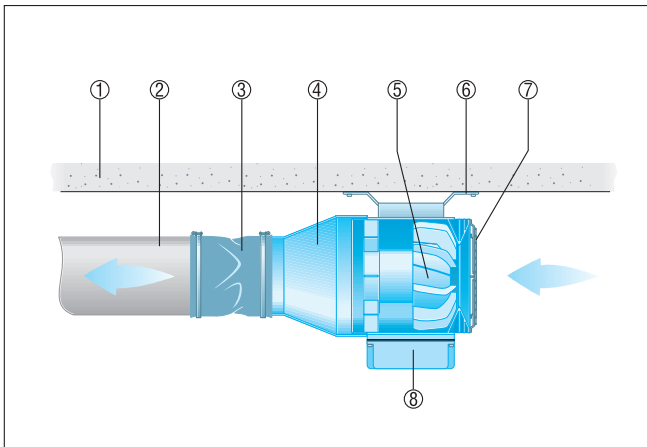

- ① Ceiling, girder
- ② Ventilation duct, to be provided by the customer
- ③ ELM-Ex flexible cuffs
- ④ REM-Ex reducer
- ⑤ ERM-Ex fan
- ⑥ FUM mounting foot
- ⑦ SGM-Ex protective grille
- ⑧ Terminal box