

ERM 28

Installation in ventilation ducts

- The illustration shows the installation of an ERM fan within a duct system.
- Use the FUM foot to mount the fan on the wall or the ceiling. The mounting foot can be secured at any position on the fan circumference with the screws supplied.

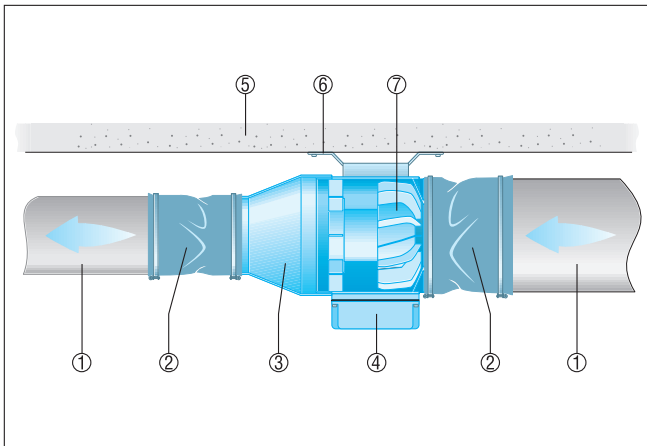

- ① Ventilation duct, to be supplied by the customer
- ② ELM flexible cuffs
- ③ REM reducer
- ④ Terminal box
- ⑤ Ceiling, wall, girder
- ⑥ FUM mounting foot
- ⑦ ERM fan

Installation at end of duct, fan with free inlet

- The illustration shows the installation of an ERM fan at the end of a duct system.
- Use the FUM foot to mount the fan on the wall or the ceiling. The mounting foot can be secured at any position on the fan circumference with the screws supplied.
- Use SGM protective grille for free outlet.

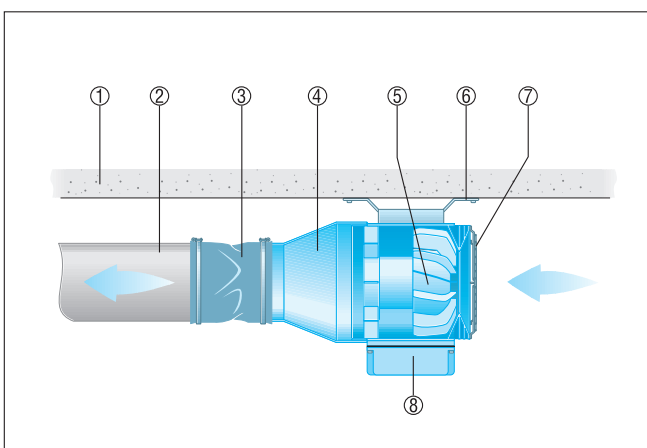

- ① Ceiling, wall, girder
- ② Ventilation duct, to be supplied by the customer
- ③ ELM flexible cuffs
- ④ REM reducer
- ⑤ ERM fan
- ⑥ FUM mounting foot
- ⑦ SGM protective grille
- ⑧ Terminal box

ERM 28

Rooms with bar equipment

- The illustration shows the construction of a duct system for extracting CO₂ or N emissions in rooms with bar equipment.
- Use SGM protective grille for free inlet

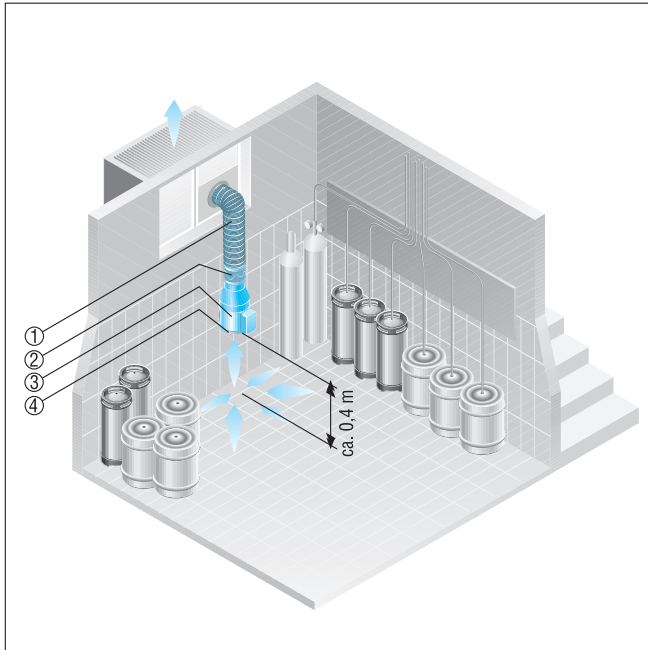

- ① Ventilation duct, to be supplied by the customer
- ② ELM fixing cuff
- ③ ERM fan
- ④ SGM protective grille