

## ERR 20/1

### Supply and exhaust air with electric air heater

The diagram shows the interaction between the various components of a ventilation system:

The air filter, fan and electric air heater follow one another in the supply air ducts. The ETL temperature control system with FR 30 P temperature sensor controls the temperature of the supply air using an electric air heater.

The fan and shutter are positioned one after another in the exhaust duct.

A 5-step transformer controls the fans in the exhaust and supply air ducts, thereby ensuring that the neighbouring room is ventilated and air extracted from it in a coordinated way.

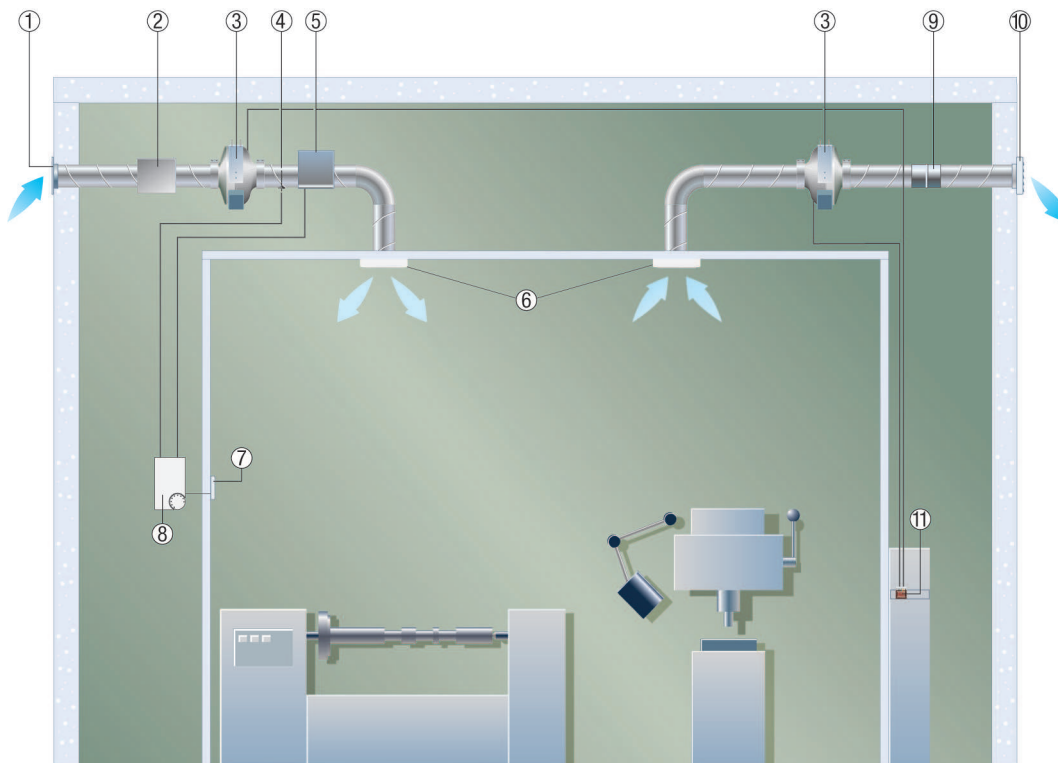

- ① MLA / MLZ external grille
- ② TFE... air filter
- ③ ERR Duct fan
- ④ LW 9 air flow monitor
- ⑤ ERH electrical air heaters
- ⑥ LGA / LGZ internal grilles
- ⑦ FR 30 P room temperature sensor
- ⑧ ETL electronic temperature control system
- ⑨ AVM Backflow preventer
- ⑩ AS shutter
- ⑪ Control cabinet with TR..S 5-step transformer with ESS 20 5-step switch

### Air extraction from public toilets using ERR duct fan

The ERR duct fans are suited to all locations offering little space for a ventilation system. Their low mounting height means that they fit easily in suspended ceiling. This allows the ventilation ducts to be fitted with ease.

In the example shown, an ERR centrifugal duct fan is extracting the exhaust air from public toilets to the outside. An RSR sound absorber in the ventilation duct prevents the noise from spreading in an unwanted fashion.

The exhaust air is extracted by disk valves or air grilles in the ceiling above the sanitary equipment. A sufficient volume of supply air automatically flows in through the MLK door ventilation grille.

## ERR 20/1

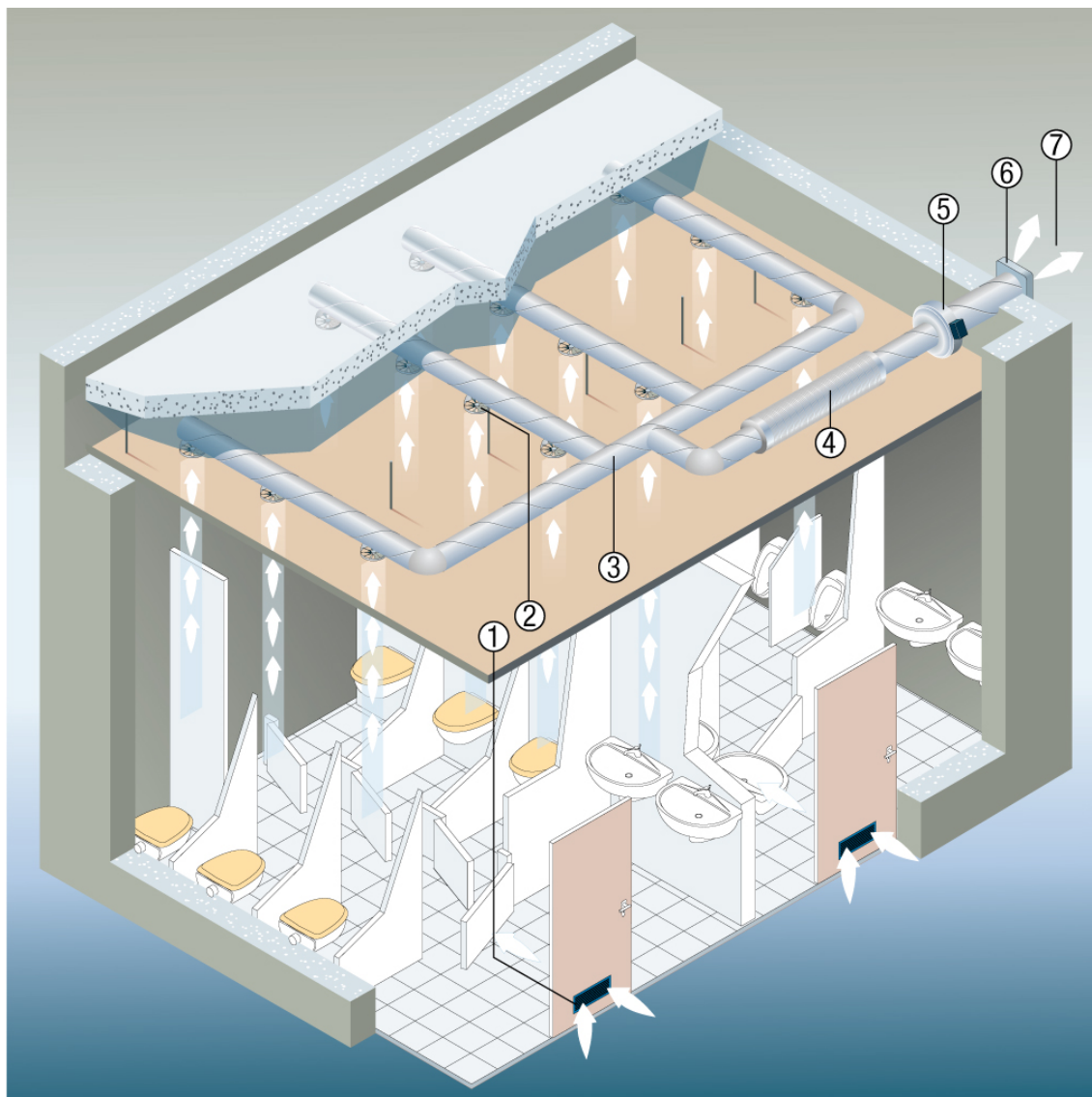

- ① MLK door ventilation grille
- ② Exhaust air elements
- ③ Exhaust air duct system
- ④ RSR tubular sound absorber
- ⑤ ERR Centrifugal duct fan
- ⑥ External grille / shutter
- ⑦ Outgoing air

## ERR 20/1

Air extraction from and ventilation of workplaces.

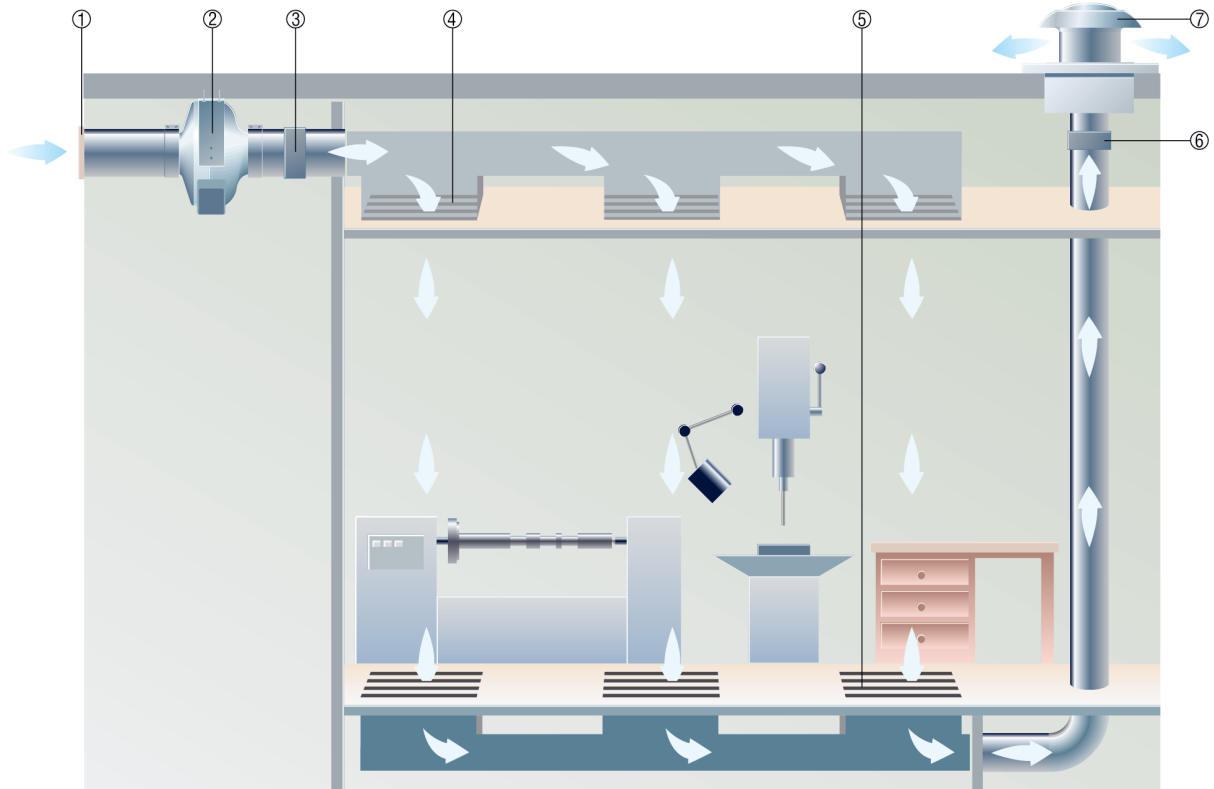

- ① MLA or MLZ external grille
- ② ERR Centrifugal duct fan
- ③ AVM Backflow preventer
- ④ Supply air grille
- ⑤ Extraction grille
- ⑥ VE Shutter
- ⑦ DZD Roof fan

### ERR fan ceiling installation

- The illustration shows the ceiling installation of an ERR fan within a duct system.
- Use FUR foot to mount the fan.
- Use an SGR protective grille for free inlet or outlet.

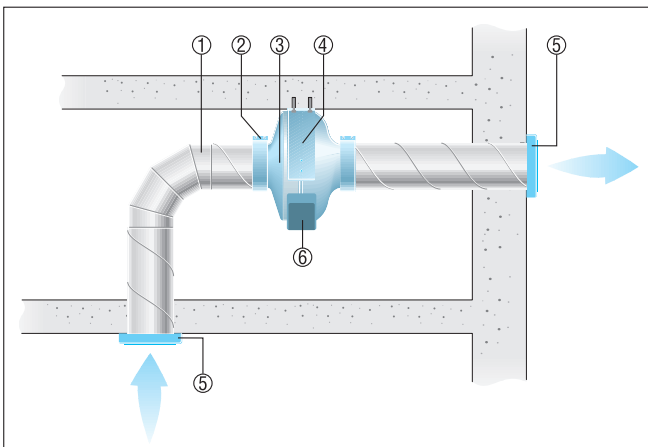

## ERR 20/1

- ① Ventilation duct, to be supplied by the customer
- ② ELR fixing cuff
- ③ ERR fan
- ④ FUR mounting foot
- ⑤ SG protective grille
- ⑥ Terminal box

### Wall installation and ERR fan with free outlet

- The illustration shows the installation of an ERR fan within a duct system and at the end of the duct.
- Use the FUR foot to mount the fan.
- Use the SGR protective grille for free outlet.

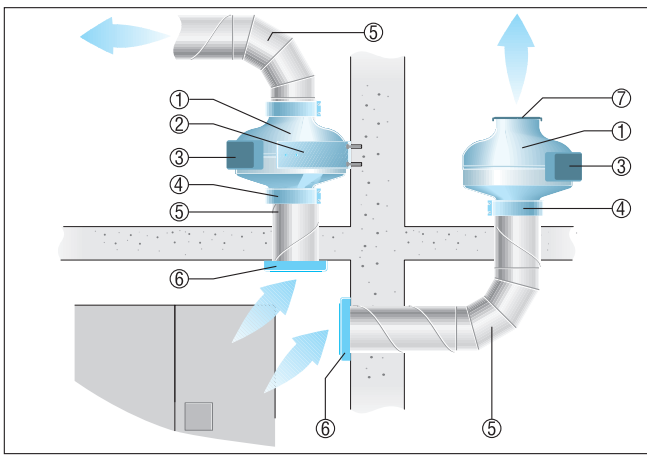

- ① ERR fan
- ② FUR mounting foot
- ③ Terminal box
- ④ ELR fixing cuff
- ⑤ Ventilation duct, to be supplied by the customer
- ⑥ SG protective grille
- ⑦ SGR protective grille

### Mounted on a bracket, air extraction via extractor hood.

- The illustration shows the construction of a duct system for extraction via an extractor hood. The fan is mounted on a bracket.
- Use an external grille for free outlet at the external wall.

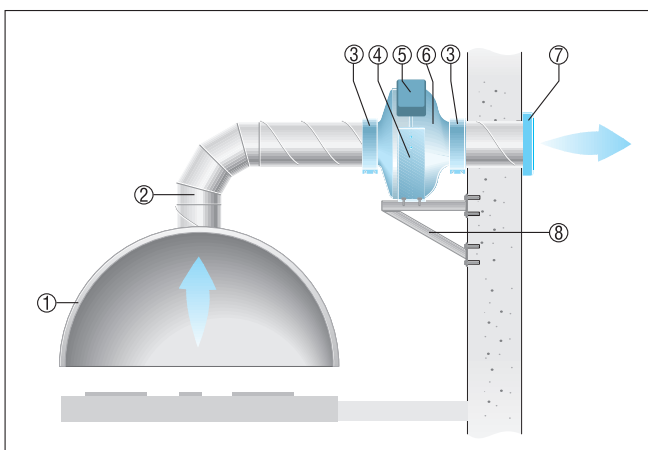

- ① Extractor hood, to be supplied by the customer
- ② Ventilation duct, to be supplied by the customer
- ③ ELR fixing cuff

# INSTALLATION INSTRUCTIONS



## ERR 20/1

- ④ FUR mounting foot
- ⑤ Terminal box
- ⑥ ERR fan
- ⑦ Protective grille
- ⑧ Bracket, to be supplied by the customer