

ESQ 40/4

Variable installation of ventilation sockets for ESQ / DSQ and ESQ K / DSQ K Quickboxes

- The panel with the socket for the air outlet can be fitted on various sides of the Quickbox. Different flow directions can therefore be easily obtained. On the one hand, a straight flow of air is possible - then the air inlet and outlet are fitted on opposite sides of the Quickbox. On the other hand, the air outlet can be rotated 90° from the air inlet.
- This allows ventilation systems to be configured in any way.
- For ESQ K / DSQ straight ducting (1) is not possible.

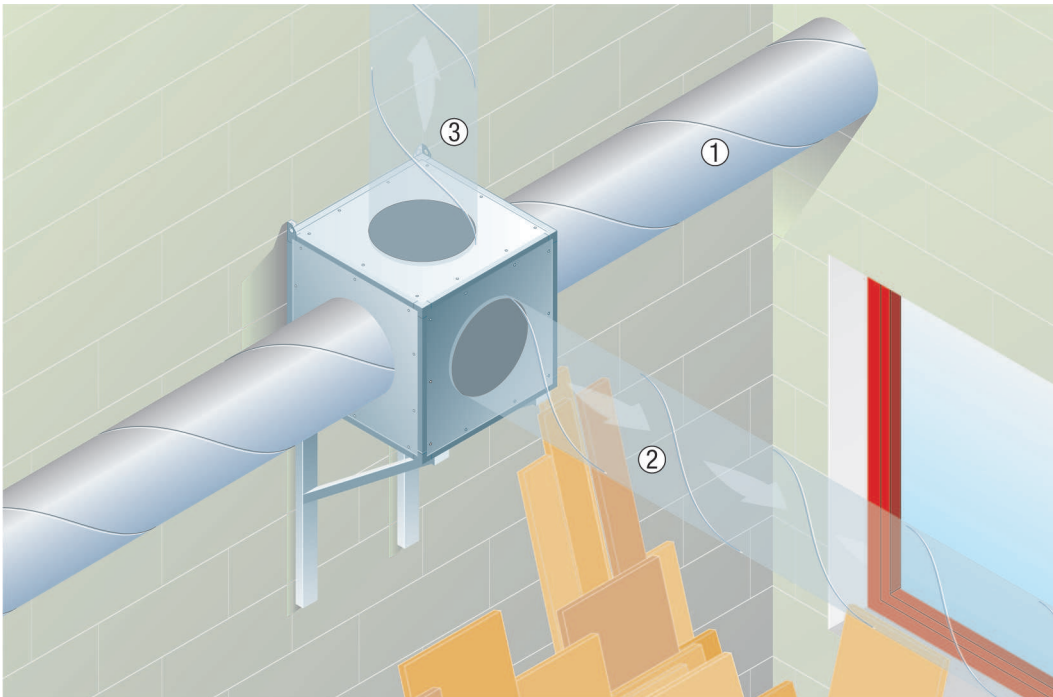

1 - 2 - 3 - Variable installation direction

Fitting Quickbox outdoors

- The ESQ and DSQ fans can be fitted both inside and outside the building. To reduce noise levels indoors, we would therefore recommend fitting on the roof.
- In such cases, an additional weather protection roof must be **fitted**.

