

ESR 20-2

Ventilation and air extraction for conference rooms using ESR EC-2 duct fans

- The ESR EC-2 sound-insulated ventilation boxes are perfect for locations where the ventilation system has to be particularly quiet. The sound insulation is made from sound absorbing rock wool and is several centimetres thick which makes it ideal for conference rooms, offices and meeting rooms. The ventilation boxes can therefore be fitted directly in the ventilation ducts under the ceiling.
- The unit's cover can be opened for maintenance purposes without using any tools. What's more, the fan can be swivelled out to further simplify service work.
- In the example shown, an ESR EC-2 sound-insulated ventilation box is supplying a teaching staff room with supply air. An ERH electric air heater, RSR tubular sound absorber and internal grille complete the supply air pipe. The air inlets and outlets are spread over the entire ceiling such that the room receives optimum cross-ventilation. The ESR EC-2 sound-insulated ventilation box then transports the exhaust air via the exhaust air system to the outside.

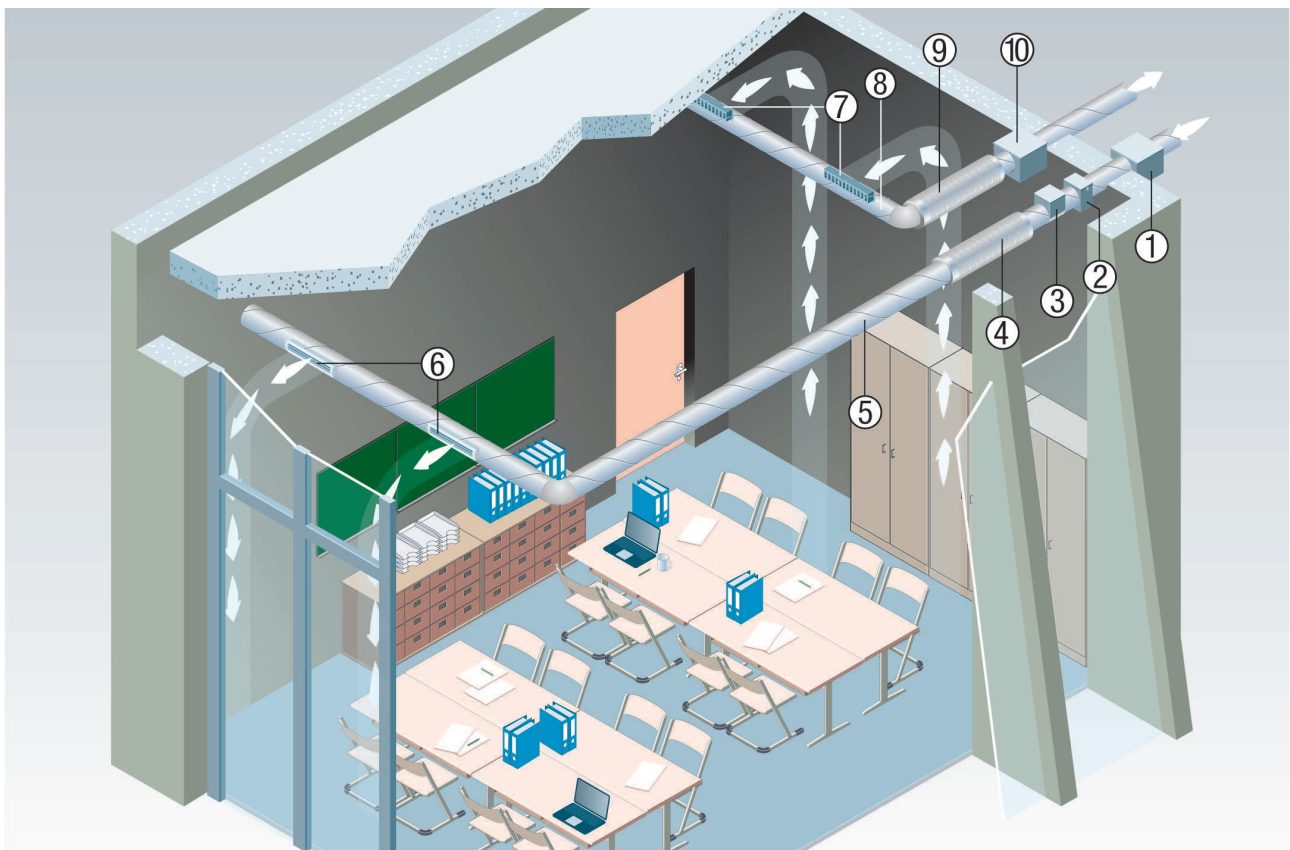

- ① ESR EC-2 sound-insulated ventilation box
- ② TFE air filter
- ③ ERH / DRH electrical air heater
- ④ RSR tubular sound absorber
- ⑤ Duct system supply air
- ⑥ Internal grille for supply air
- ⑦ Internal grille for exhaust air
- ⑧ Duct system exhaust air
- ⑨ RSR tubular sound absorber
- ⑩ ESR EC-2 sound-insulated ventilation box

Ceiling assembly with housing opening at the bottom

- Use 4 mounting components to mount the ventilation box. Mounting components must be supplied by the customer.

ESR 20-2

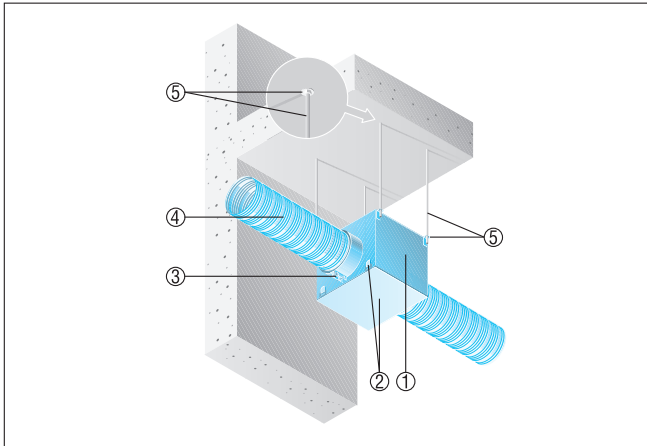

- ① ESR sound-insulated ventilation box
- ② Housing cover with clip lock
- ③ ELR fixing cuff
- ④ Ventilation duct, to be supplied by the customer
- ⑤ Mounting components, to be supplied by the customer

Ceiling assembly with housing opening on top

- Use 4 mounting components to mount the ventilation box. Mounting components must be supplied by the customer.
- Allow sufficient space to the ceiling for maintenance and cleaning.

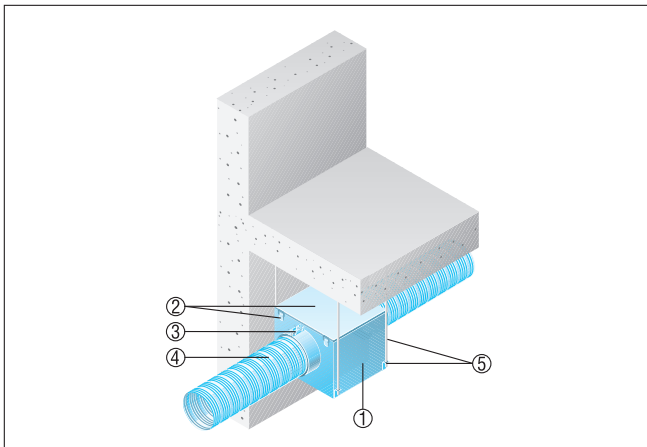

- ① ESR sound-insulated ventilation box
- ② Housing cover with clip lock
- ③ ELR fixing cuff
- ④ Ventilation duct, to be supplied by the customer
- ⑤ Mounting components, to be supplied by the customer