

INSTALLATION INSTRUCTIONS

EZD 30/2 B

Tile roofs

- The SDS pitched roof socket is specially manufactured for mounting on tiled roofs.
- The type of roof tiles and roof pitch must be given at the time of ordering.

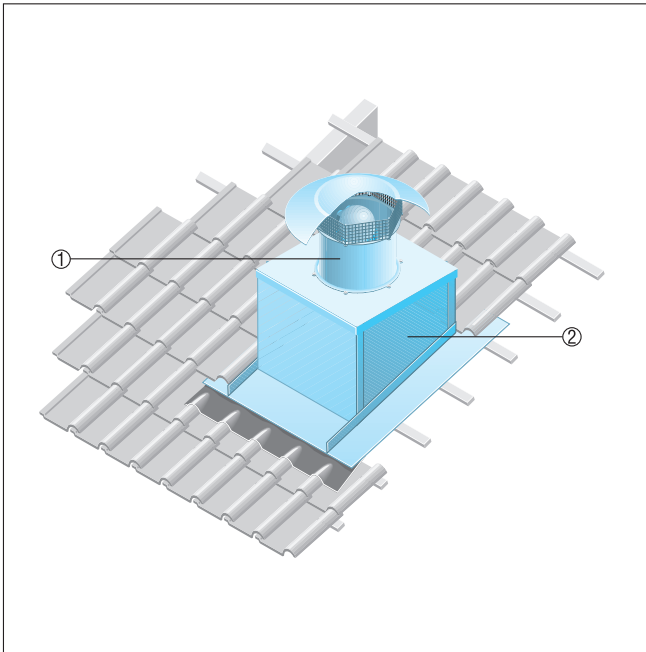

- ① EZD, DZD axial roof fan
- ② SDS pitched roof socket

Corrugated or trapezoidal roofs

- The SOWT corrugated and trapezoidal roof socket is suitable for use with all types of trapezoidal and corrugated roofs.
- The roof pitch must be given at the time of ordering.

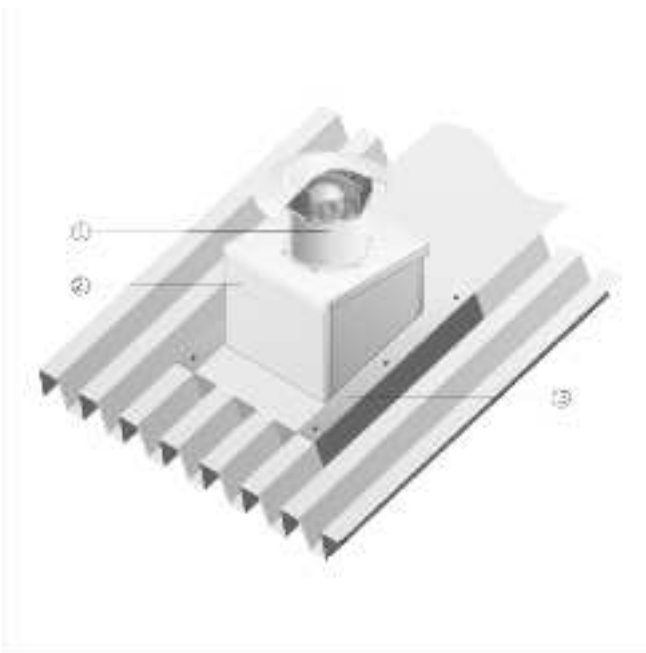

- ① EZD or DZD axial roof fan
- ② SOWT corrugated and trapezoidal roof socket
- ③ Roof-mounted connector, to be supplied by the customer

INSTALLATION INSTRUCTIONS

EZD 30/2 B

Flat roofs

- We recommend using an SD socket sound absorber for EZD and DZD fans.
- The SD socket sound absorber dampens the noise on the suction side.

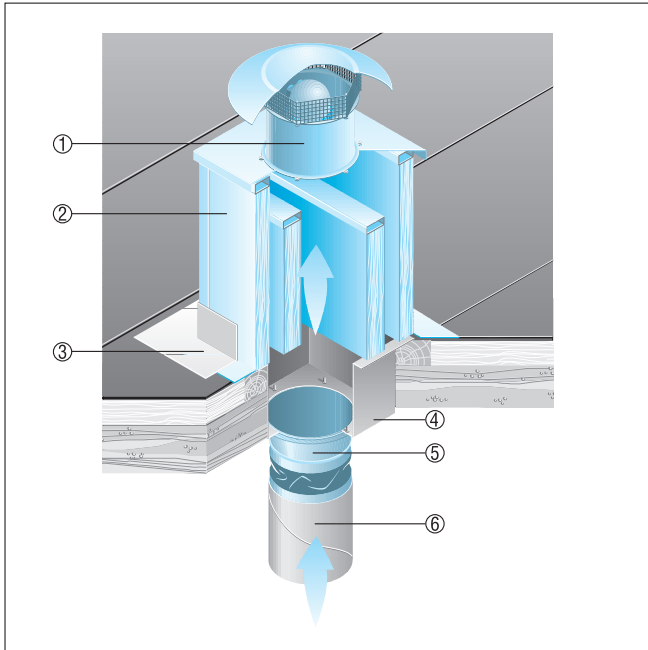

- ① EZD, DZD axial roof fan
- ② SD socket sound absorber
- ③ Roof-mounted connector, to be supplied by the customer
- ④ Connection socket, to be supplied by the customer
- ⑤ ELA flexible coupling
- ⑥ Ventilation duct, to be supplied by the customer