

INSTALLATION INSTRUCTIONS

PDH 15

Wall assembly

- The fan heater can be mounted in a forward tilted position at an angle of 7.5° or 15°.
 - Additionally, the fan heater can also be mounted turned horizontally through 30°.
- Remove tubular stand for wall assembly.

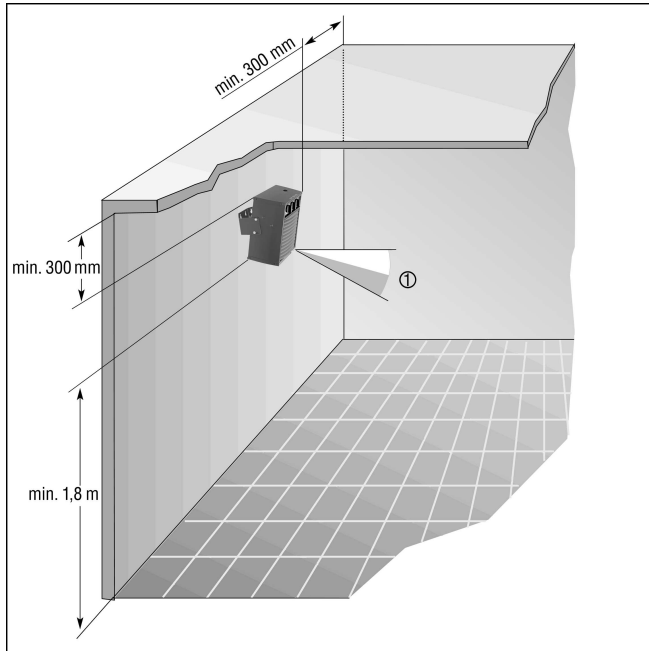

① PEH fan heater