

INSTALLATION INSTRUCTIONS

SZ 22

Flat roofs

- With SD socket sound absorber for sound insulation on intake side.

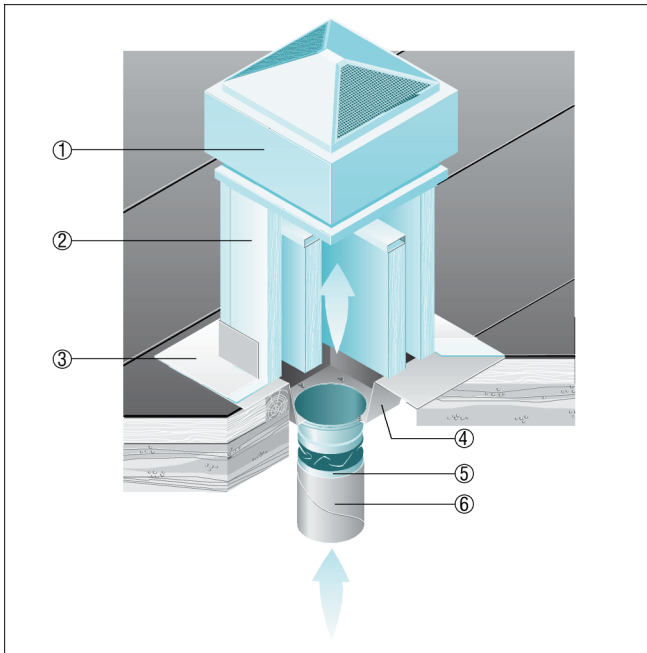

- ① ERD, DRD centrifugal roof fan
- ② SD socket sound absorber
- ③ Roof-mounted connector, to be supplied by the customer
- ④ SZ intermediate sockets
- ⑤ ELA flexible coupling
- ⑥ Ventilation duct, to be supplied by the customer