

## WHP 56-69

### Installation instructions

Mount the water-air heater on the fan's pressure side in order to prevent the fan motor overheating.

Mount a 1 m to 1.5 m long air duct fitting between the fan and the water-air heater to ensure optimum inflow to the water-air heater.

Mount the forward and reverse flow of the water circuit in the opposite direction to the air flow. DC operation reduces the heater power rating of the water-air heater.

Install the TFP air filter to prevent pressure losses caused by pollution of the water-air heater.

Provide devices for frost protection and air extraction.

Maintain the water mass flow in the heating register at a constant level with temperature control.

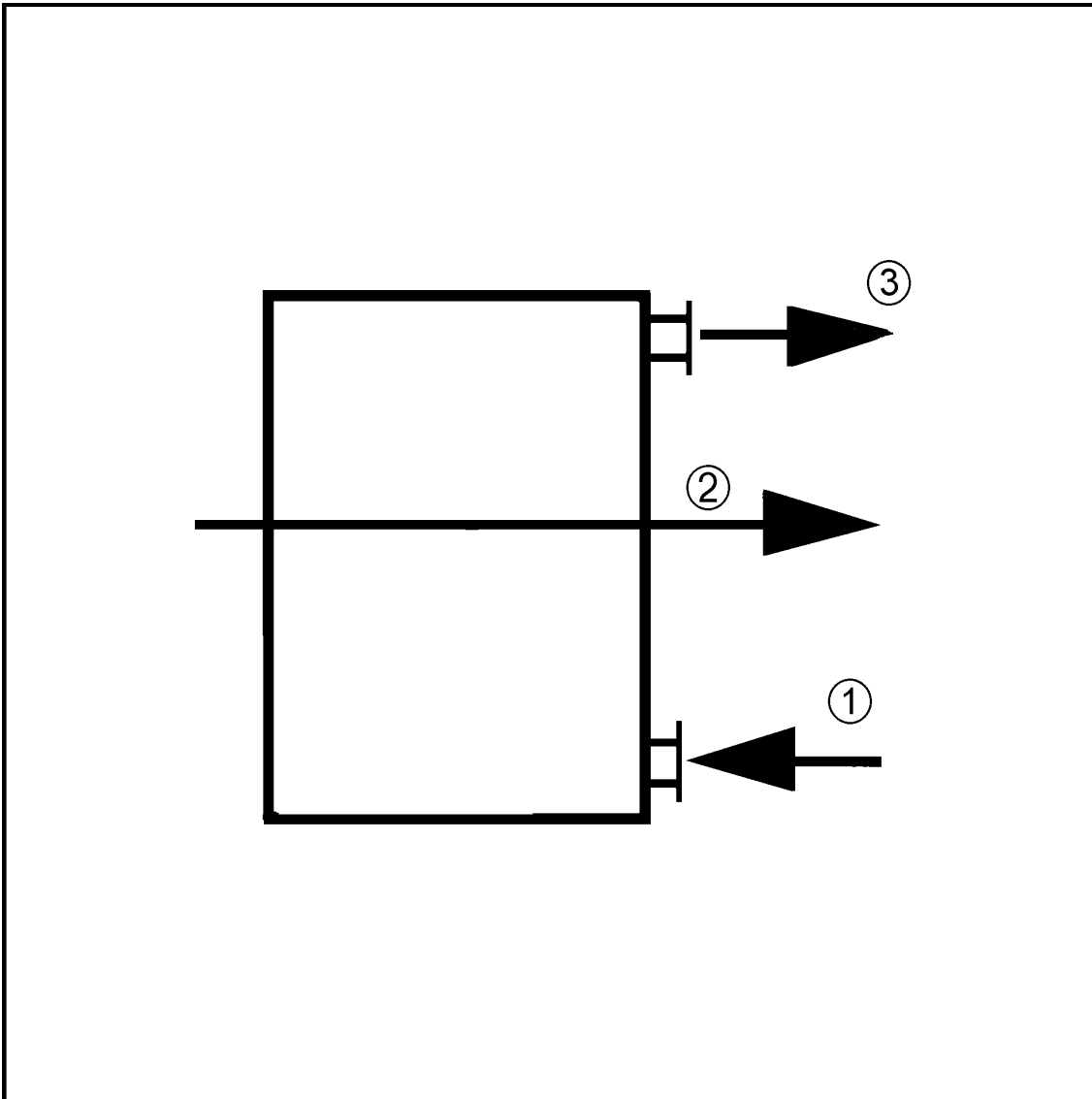

- ① Forward flow
- ② Air direction
- ③ Reverse flow