

Comfortable climate for apartments and single-family homes



From the exhaust air solution to
heat recovery

Intelligent German-made
ventilation systems



Table of contents

Systems without heat recovery

ECA 100 ipro Decentralised ventilation of bathrooms and WCs with flush-mounted wall fans	4
AKE / AKE 100 / AKE 150 Fully automatic cellar dehumidification	6
ER EC fans for decentralised air extraction of bathrooms and WCs in accordance with DIN 18017-3 / DIN 1946-6	8
CENTRO Central ventilation of bathrooms and WCs in accordance with DIN 18017-3 / DIN 1946-6	10

Systems with heat recovery

PP 45 Decentralised ventilation of flats with heat recovery	12
PPB 30 Decentralised ventilation of bathrooms, WCs and kitchens with heat recovery	14
WS 75 Powerbox Decentralised ventilation of small residential units and for practice, office and business premises with heat recovery up to 60 m ²	16
WS 75 Powerbox S Central ventilation of small residential units and for practice, office and business premises with heat recovery up to 60 m ²	18
WS 120 Trio Central ventilation of flats with heat recovery up to 100 m ²	20
WS 160 Flat Central ventilation of flats with heat recovery up to 140 m ²	22
WS 170 Central ventilation of flats with heat recovery up to 140 m ²	24
WS 300 Flat Central ventilation of flats with heat recovery up to 300 m ²	26
WS 320 Central ventilation of flats with heat recovery up to 300 m ²	28
WS 470 Central ventilation of flats with heat recovery up to 450 m ²	30
Duct systems MAICOFlex, MAICOAir, MAICOTherm	32



Damp, mold and mildew in basements are a thing of the past.

AKE – the fully automatic cellar dehumidification



**Dehumidification combined
with powerful fans
AKE | AKE 100 | AKE 150**

Humidity protection
for cellars!

Permanent comparison
of the absolute indoor
and outdoor humidity



Animation video:
Simple and quick
installation

ECA 100 ipro

Decentralised ventilation of bathrooms and WCs with flush-mounted wall fans



MODE OF OPERATION

- Installation on exterior wall or ceiling
- Outgoing air ducting directly or via short DN 100 ducts to the exterior wall/roof
- Switching via light switch or integrated sensors for humidity or movement

MAICO highlights

- 2 operating levels
- Adjustable operating programmes for different purposes ensure optimal performance and quietest operation
- Optional electric internal shutter against heat loss and draughts
- ECA 100 ipro H with fully automatic 2-level humidity control

ECA 100^{ipro}



Variable and intelligent small room fans for bathrooms, WCs or storage rooms

ECA 100 ipro

Decentralised ventilation of bathrooms and WCs with flush-mounted wall fans



VENTILATION COMPONENTS FOR A BATHROOM OR WC (example)

1 ECA 100 ipro VZC

1 AP 100 shutter, 1 SG 100 external grille, optional

1 WH 100 wall sleeve

1 MLK door ventilation grille

① AP 100 shutter for air extraction

② WH 100 wall sleeve

③ ECA 100 ipro VZC small room fan

④ MLK 45 door ventilation grille

Now also with radio control!



AKE / AKE 100 / AKE 150

The fully automatic cellar dehumidification



MAICO's automatic cellar dehumidification provides fully automatic and reliable air extraction in individual cellars or utility rooms as well as cellars in residential buildings, warehouses or garages

MODE OF OPERATION

- Ventilation unit with intelligent dew point control
- Prevents humid outside air from flowing into the cellar
- Automatic operation only when absolute air humidity outside is lower than inside
- AKE – Dehumidification in combination with powerful fans
- AKE 100 up to approx. 30 m², AKE 150 up to approx. 70 m²

MAICO highlights

- Dew point control and humidity sensors integrated in the unit, no additional wiring required
- Additional fans without their own dew point control can be controlled, e.g. for larger rooms or for providing supply air
- Frost protection function switches off at temperatures < 5° C

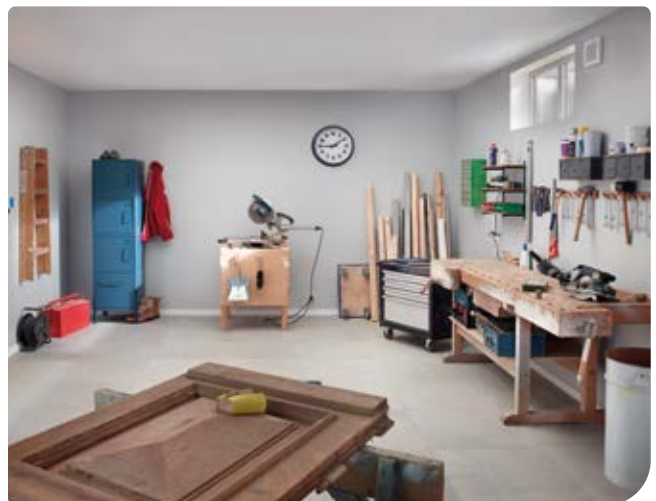

AKE / AKE 100 / AKE 150

The fully automatic cellar dehumidification

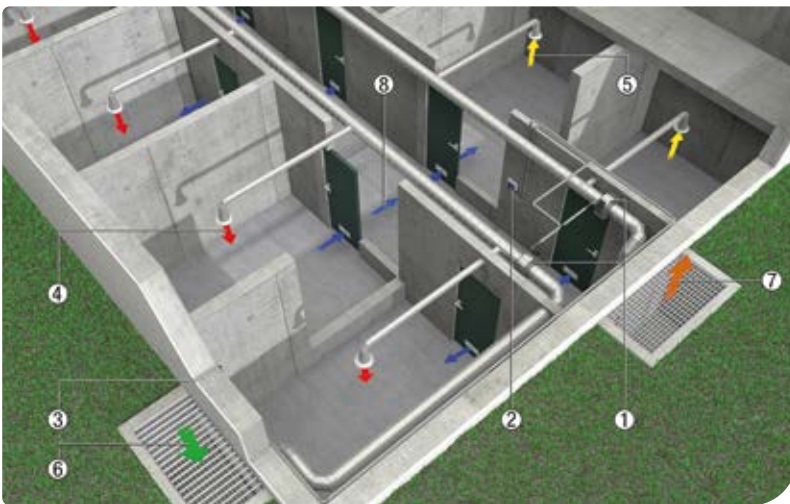

AKE application example

The AKE control system can be used to control a wide variety of fan types. Even an existing ventilation system can be converted into an automatic cellar dehumidification system with all its advantages.

- ① Fan (e.g. ERR centrifugal duct fan)
- ② Automatic AKE cellar dehumidification control
- ③ External humidity sensor
- ④ Supply air
- ⑤ Exhaust air
- ⑥ Outside air
- ⑦ Outgoing air
- ⑧ Overflow air



ERR centrifugal duct fan



AKE 100 / AKE 150 application example

As stand-alone systems, the AKE 100 and AKE 150 ventilation systems are perfect for independent dehumidification of cellars and utility rooms.

- ① AKE 100
Consisting of:
Fan with sensor
External shutter with sensor
- ② WH 100
- ③ MLK 45 overflow opening

ER EC fans

for decentralised air extraction in accordance with DIN 18017-3/DIN 1946-6



Exhaust air system with single air extraction units for construction of new multiple-family homes, homes, hotels.

MODE OF OPERATION

Exhaust air

- Individual air extraction units in bathrooms, WCs, kitchens
- Outgoing air flow via shared outgoing air duct for several flats
- Fire protection in the outgoing air duct thanks to fire protection barriers in the floor ceilings

Supply air

- Fresh outside air supply via outside air openings into the day rooms (living spaces)

MAICO highlights

- Air extraction units with energy-saving EC motor
- A universal fan insert
- Only four different covers with integrated control for
 - 5 fan levels
 - adjustable overrun and interval times
 - humidity or motion sensor
- Elegant, very sound-insulated outside air openings

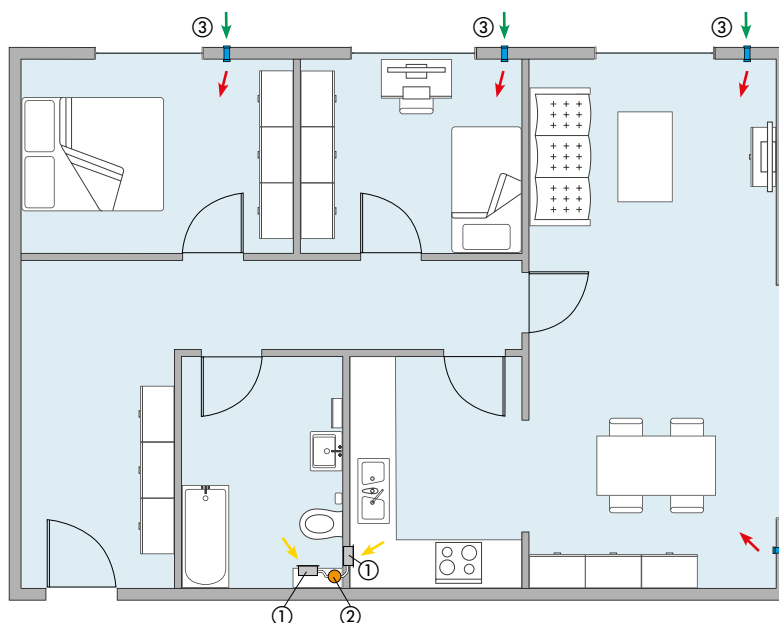

For exhaust air rooms

- ① ER EC fan insert with
 - ER GH flush-mounted housing
 - ER-AK cover
 - ER-AH cover
 Optional:
 - ER EC fan insert with
 - ER GH AP surface-mounted housing
 - ER-AK or ER-AH cover
- ② Central exhaust air duct

For supply air rooms

- ③ ALD outside air opening

■ Supply air ■ Exhaust air ■ Outside air ■ Outgoing air

ER EC fans

for decentralised air extraction in accordance with DIN 18017-3/DIN 1946-6



- ① DP roofing tile + roof outlet with DF hood
- ② ER EC individual air extraction unit with ER-GH housing and ER-AK or ER-AH cover
- ③ ALD outside air opening
- ④ TS 18 ceiling barrier

■ Supply air ■ Exhaust air ■ Outside air ■ Outgoing air

MATERIAL PER RESIDENTIAL UNIT (example 3-room flat)

FAN INSERT FOR KITCHEN AND BATHROOM	ART. NO.	QUANTITY
ER EC single duct air extraction unit	0084.0360	2

COVER WITH CONTROL	ART. NO.	QUANTITY
ER-AK cover with comfort control for kitchen	0084.0362	1
ER-AH cover with humidity control for bathroom	0084.0363	1

FLUSH-MOUNTED HOUSING FOR ER EC	ART. NO.	QUANTITY
ER GH flush-mounted housing	0084.0350	2

Optional

SURFACE-MOUNTED HOUSING FOR ER EC	ART. NO.	QUANTITY
ER GH AP surface-mounted housing	0084.0352	2

INDIVIDUAL COMPONENTS FOR OUTSIDE AND SUPPLY AIR	ART. NO.	QUANTITY
ALD 160 outside air opening for passive air intake	0152.0069	4



CENTRO –

Central ventilation of bathrooms and WCs in accordance with DIN 18017-3 / DIN 1946-6



Energy-saving central air extraction system with central roof fan in accordance with DIN 18017-3

MODE OF OPERATION

- Common roof fan for all flats
- Exhaust air elements for basic and demand-based ventilation in bathrooms + WCs
- Switching of demand-based ventilation via light switch or humidity sensor in the exhaust air element
- Fresh outside air supply via outside air openings in the flats

MAICO highlights

- Energy-saving EC roof fan with integrated pressure constancy control
- Elegant exhaust air elements for flush or surface mounting; switchable from basic to demand-based ventilation, optionally humidity-controlled
- Simplest adjustment of the system without measuring instruments, without PC
- No telephony sound absorber required, integrated cold smoke barriers
- Attractive, particularly sound-insulated outside air openings

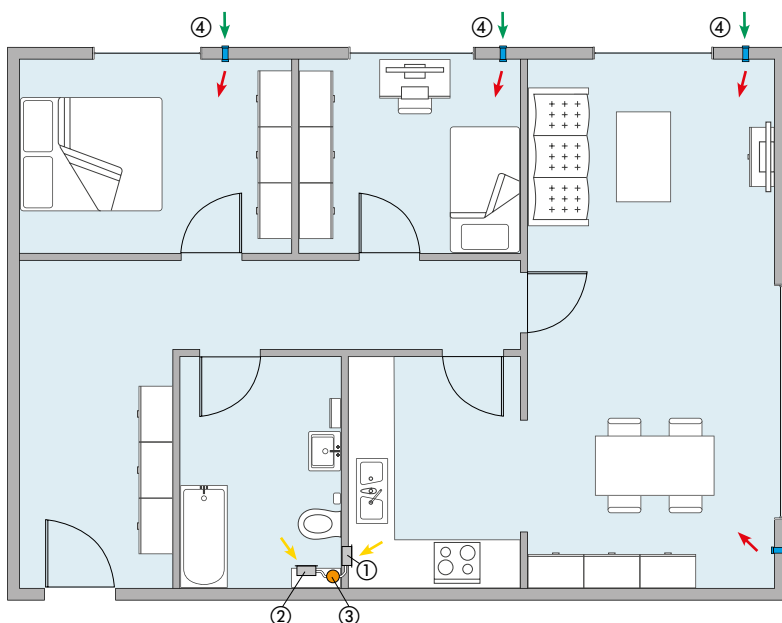

VENTILATION COMPONENTS PER RESIDENTIAL UNIT

For exhaust air rooms:

- ① CENTRO-E in ER-UP/G flush-mounted housing
- ② CENTRO-H in ER-UP/G flush-mounted housing
- ③ Central exhaust air duct

For supply air rooms

- ④ ALD outside air openings for supply air rooms

■ Supply air ■ Exhaust air ■ Outside air ■ Outgoing air

CENTRO –

Central ventilation of bathrooms and WCs in accordance with DIN 18017-3 / DIN 1946-6

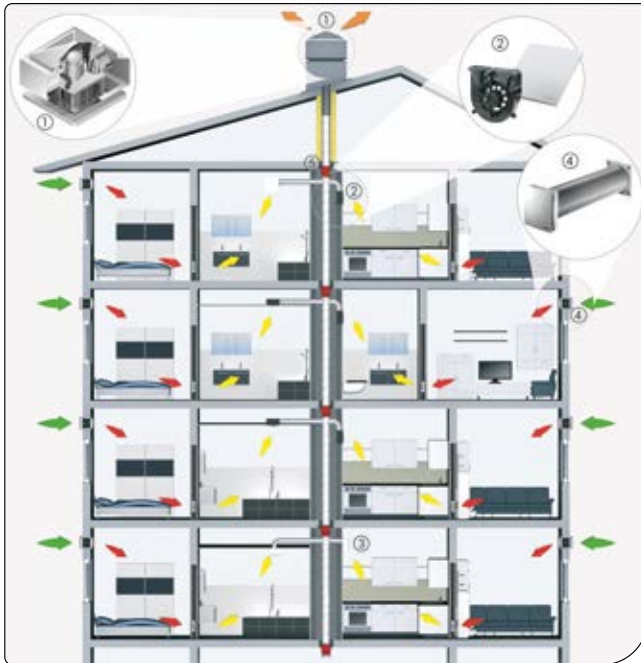

- ① MDR-PG 18 centrifugal roof fan with EC motor and integrated control
- ② Centro exhaust air element in ER-UP/G flush-mounted housing
- ③ Centro exhaust air element in surface-mounted model
- ④ ALD outside air opening
- ⑤ TS 18 ceiling barrier

■ Supply air ■ Exhaust air ■ Outside air ■ Outgoing air

MATERIAL COMMON TO ALL CONNECTED RESIDENTIAL UNITS

CENTRIFUGAL ROOF FAN (FOR 4 RESIDENTIAL UNITS)	ART. NO.	QUANTITY
MDR-PG 18 centrifugal roof fan with regulation	0087.0031	1



ROOF SOCKET FOR PITCHED ROOFS	ART. NO.	QUANTITY
SDS 22 pitched roof socket for tiled roofs	0093.1028	1



MATERIAL PER RESIDENTIAL UNIT (example 3-room flat)

EXHAUST AIR ELEMENT FOR KITCHEN AND BATHROOM	ART. NO.	QUANTITY
CENTRO-E (2-level)	0084.0183	1
CENTRO-H (2-level, humidity-controlled)	0084.0187	1



FLUSH-MOUNTED HOUSING FOR CENTRO	ART. NO.	QUANTITY
ER-UP/G flush-mounted housing	0093.0995	2



INDIVIDUAL COMPONENTS FOR OUTSIDE AND SUPPLY AIR	ART. NO.	QUANTITY
ALD 160 outside air opening for passive air intake	0152.0069	4



PP 45

Decentralised ventilation of apartments with heat recovery



PushPull 45
MAICO



Wall sleeve just Ø 160 mm



Decentralised wall-mounted ventilation unit with heat recovery for living spaces

MODE OF OPERATION

- Wall-mounted unit with alternating exhaust air and supply air mode for ventilating living spaces
- In exhaust air mode, > 84% of heat is stored and then returned when in supply air mode
- At least 2 units needed
- Damp rooms and kitchens can be included in the ventilation system with exhaust air fans or PPB 30 K
- Central control with RLS 45 K control panel with various ventilation modes

MAICO highlights

- Quietest unit in its class
- Efficiency class A+
- > 84% heat recovery
- Flow-optimised external covers direct air flow away from façade and protect it from soiling
- Diameter only 160 mm
- Odd number of units possible
- Pitched roof version available as an option

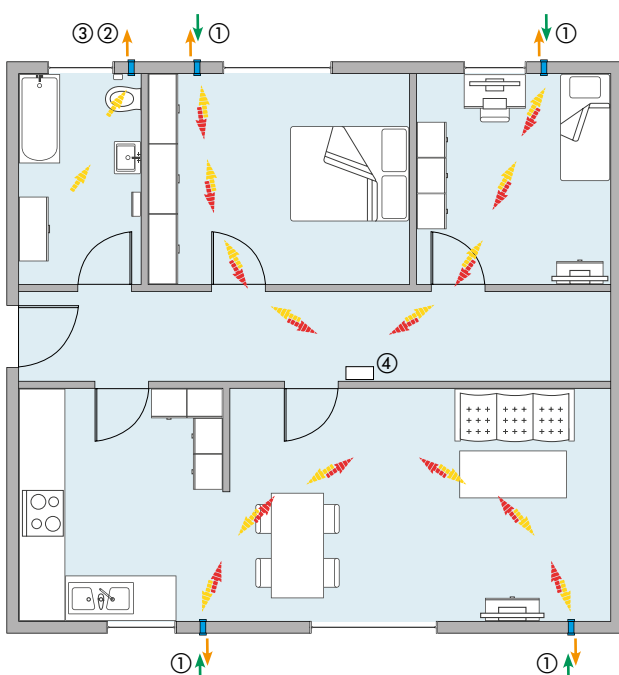

- ① PushPull 45 ventilation unit in continuous operation with heat recovery
- ② ECA 100 ipro
- ③ PPB 30 ventilation unit in continuous operation with heat recovery as an option
- ④ RLS 45 K control panel

 Supply and exhaust air with change of direction

 Outside and outgoing air with change of direction

PP 45

Decentralised ventilation of apartments with heat recovery

MATERIAL PER RESIDENTIAL UNIT (example)

FINAL INSTALLTION KIT	ART. NO.	QUANTITY
PP 45 K comfort variant with electrical internal shutter	0095.0241	4



SHELL SLEEVE	ART. NO.	QUANTITY
Ø 160 mm		
① 500 mm shell sleeve, PP 45 RHK	0059.0081	4
Optional:		
② 800 mm shell sleeve, PP 45 RHL	0059.0082	optional
③ Sound-absorbing element, PP 45 SE	0093.0308	optional

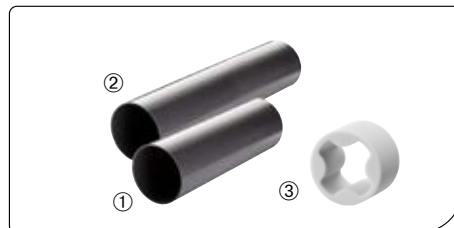

OPTIONAL ACCESSORIES FOR SHELL SLEEVE	ART. NO.	QUANTITY
Wall block, thermally insulated, 365 mm deep, can be shortened, PP 45 MB	0058.0143	optional



INDIVIDUAL COMPONENTS FOR OUTSIDE AND OUTGOING AIR	ART. NO.	QUANTITY
① External cover, white plastic, PP 45 AK	0093.0176	4
Optional:		
② External cover, brushed stainless steel, PP 45 AE	0093.0177	optional
③ External cover, plastic, PP 45 AKR	0093.1635	optional
④ Soffit element, PP 45 LE with stainless steel cover	0093.0179	optional
⑤ Soffit element extension, PP 45 LEV	0093.1483	optional



ROOM AIR CONTROLS	ART. NO.	QUANTITY
RLS 45 K comfort variant control panel for up to 6 ventilation units	0157.0360	1



EXHAUST AIR FAN FOR BATHROOMS	ART. NO.	QUANTITY
Exhaust air fan, ECA 100 ipro H	0093.0995	1



WALL SLEEVE	ART. NO.	QUANTITY
① WH 100 wall sleeve	0059.1030	1
SHUTTER		
② AP 100 shutter	0059.1058	1



Optional ER EC exhaust air fan for indoor bathrooms

See page 6

Optional PPB 30 single-room ventilation unit with heat recovery for bathrooms

See page 14

PPB 30

Decentralised ventilation of bathrooms, WCs and kitchens with heat recovery



Decentralised, balanced supply and exhaust air unit for wall mounting with heat recovery for bathroom, WC and kitchen

MODE OF OPERATION

- Balanced supply air/exhaust air mode with heat recovery
- With switching using switch or humidity sensor, exhaust air mode in accordance with DIN 1946-6 Table 7
- Can be used as stand-alone solution or in combination with PP 45
- Control via RLS 45

MAICO highlights

- Diameter only 160 mm
- > 73% heat recovery
- Flow-optimised external covers direct air flow away from façade and protect it from soiling
- The quietest ventilation in this unit class

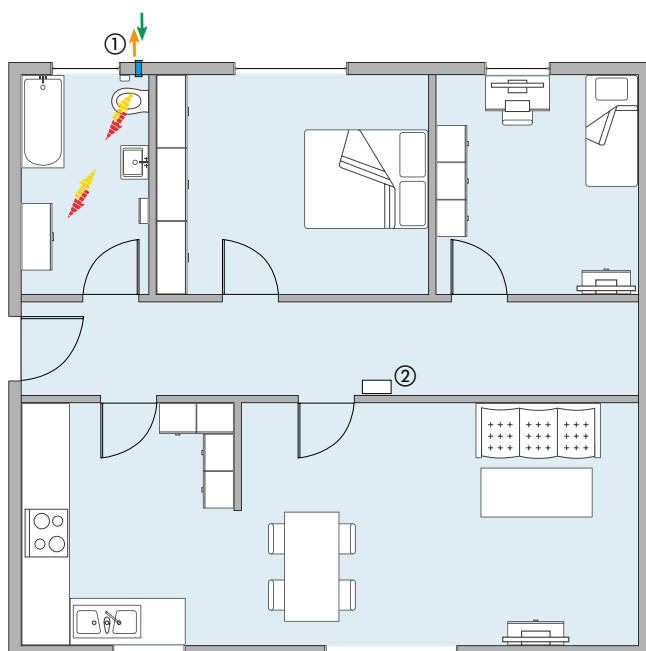

- ① PushPull 30 ventilation unit in continuous operation with heat recovery
② RLS 45 K control panel

- Supply and exhaust air with change of direction
Outside and outgoing air with change of direction

PPB 30

Decentralised ventilation of bathrooms, WCs and kitchens with heat recovery

MATERIAL PER BATHROOM / WC / KITCHEN (example)

FINAL INSTALLTION KIT	ART. NO.	QUANTITY
PPB 30 K comfort variant	0095.0246	1



SHELL SLEEVE	ART. NO.	QUANTITY
Ø 160 mm Shell sleeve 500 mm, PP 45 RHK	0059.0081	1



Optional:	ART. NO.	QUANTITY
Shell sleeve 800 mm, PP 45 RHL	0059.0082	optional
Extension set of inner fluid channel in shell sleeve 800 mm, PPB 30 VS	0093.1522	optional



OPTIONAL ACCESSORIES FOR SHELL SLEEVE	ART. NO.	QUANTITY
Wall block, thermally insulated, 365 mm deep, can be shortened, PP 45 MB	0058.0143	optional



INDIVIDUAL COMPONENTS FOR OUTSIDE AND OUTGOING AIR	ART. NO.	QUANTITY
External cover, plastic, traffic white, PPB 30 AK	0093.1498	1
External cover, aluminium, white powder-coated RAL 9010, PPB 30 AW	0093.1500	optional
External cover, aluminium, anthracite powder-coated RAL 7016, PPB 30 AS	0093.0613	optional
External cover, brushed stainless steel, PPB 30 AE	0093.1499	optional



ROOM AIR CONTROLS	ART. NO.	QUANTITY
RLS 45 K comfort variant	0157.0360	1



Complete ventilation system for flats:

PPB 30 units for exhaust air rooms and PP 45 units for supply air rooms are optimally balanced via a common control system

For PP 45 components, see page 12

WS 75 Powerbox

Decentralised ventilation of small residential units as well as for practice, office and business premises



MODE OF OPERATION

- Fully-automatic demand-driven operation via humidity sensor
 - VOC and CO2 sensors available as accessories
 - Air quality display via LED
- Innovative glass control element
- The integrated W-LAN module enables operation via the air@home app
- Very quiet ventilation due to extremely sound-absorbing and heat-insulating housing construction
- Simple installation, Plug and Play
- No condensate drain necessary thanks to enthalpy heat exchanger

MAICO highlights

- EC fans with consistent volumetric flow:
 - The volumetric flows do not require adjustment
- High energy efficiency due to EC DC motor, energy efficiency class A
- Fully automatic frost protection with continuous ventilation thanks to an innovative antifreeze circuit
- With filter change indicator, easy filter replacement
- Unit housing made of powder-coated sheet steel, painted, colour: traffic white, sheet metal and glass RAL 9016
- UP units cover made of solid glass
- Flexible arrangement (vertical and horizontal installation possible)

Flush-mounted: two-room flat

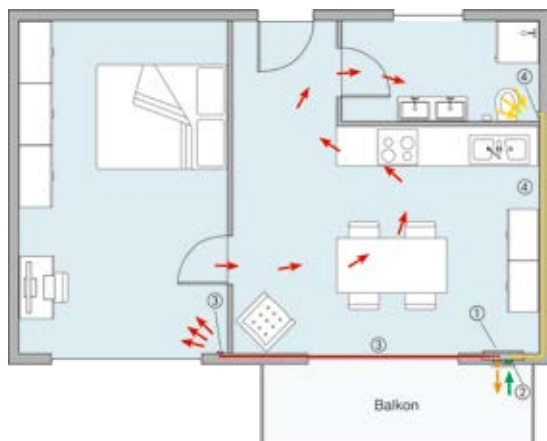

- | | |
|-------------------------------------|-------------------------------|
| ① Ventilation unit | ③ Supply air duct with valve |
| ② Outside air and outgoing air cowl | ④ Exhaust air duct with valve |

Surface-mounted: hotel room / room in nursing care facility

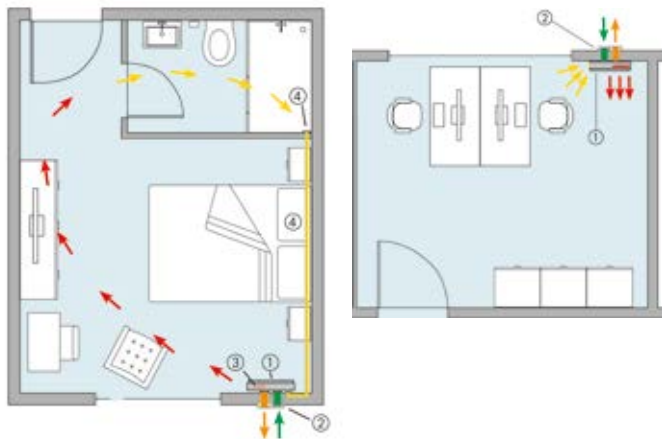

- | | |
|-------------------------------------|-------------------------------|
| ① Ventilation unit | ③ Supply air |
| ② Outside air and outgoing air cowl | ④ Exhaust air duct with valve |

■ Supply air ■ Exhaust air ■ Outside air ■ Outgoing air

WS 75 Powerbox

for residential units up to approx. 60 m²

MATERIAL PER RESIDENTIAL UNIT (example)

SURFACE-MOUNTED VARIANT		ART. NO.
Shell kit (1)	WS75 RSAP	0093.1615
Ventilation unit incl. control element (2)	WS 75 Powerbox H	0095.0646
Unit cover (3)	WS 75 APA	0093.1617
Glass insert with printed motif on request (4)		



FLUSH-MOUNTED VARIANT / OR AS A FRONT WALL INSTALLATION		ART. NO.
Shell kit (1)	WS75 RSUP	0093.1616
Ventilation unit incl. control element (2)	WS 75 Powerbox H	0095.0646
Unit cover (3)	WS 75 UPA	0093.1618
Glass insert with printed motif on request (4)		
Unit cover made of solid glass (5)	WS 75 UPGA	0093.1619



FAÇADE / EXTERNAL COVER		ART. NO.
Façade (brushed stainless steel) (1)	Duo KWS E	0093.1440
Façade (stainless steel white powder-coated RAL 9010) (2)	Duo KWS W	0093.1441
Soffit element (1)	Duo LE	0093.0087
Soffit element extension (2)	Duo LEV	0093.0089
Cover Soffit element (3)	Duo AE	0093.0088

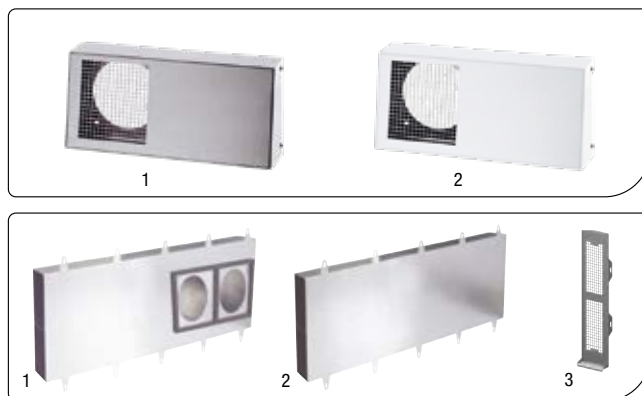

ACCESSORIES FOR WS 75 FLUSH MOUNTING		ART. NO.
Disk valve, metal for exhaust air (1)	TFA 12	0151.0370
Disk valve, metal for supply air (2)	TFZ 12	0151.0365
Mounting frame for TFA/TFZ (3)	EBR-D 12	0092.0494
Deflection piece (4)	MA-U2-75	0059.2117
Flexible duct DN 75 (5)	MF-F75	0055.0096

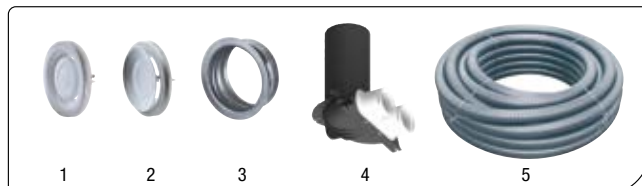

WS 75 Powerbox S

Centralised ventilation of small residential units as well as for practice, office and business premises



@home
AIR

Modbus®

KNX

enocean

MODE OF OPERATION

- Fully-automatic demand-driven operation via humidity sensor
 - VOC and CO2 sensors available as accessories
 - Air quality display via LED
- Innovative glass control element
- The integrated W-LAN module enables operation via the air@home app
- Very quiet ventilation due to extremely sound-absorbing and heat-insulating housing construction
- Simple installation, Plug and Play
- No condensate drain necessary thanks to enthalpy heat exchanger

MAICO highlights

- EC fans with consistent volumetric flow:
 - The volumetric flows do not require adjustment
- High energy efficiency due to EC DC motor, energy efficiency class A
- Fully automatic frost protection with continuous ventilation thanks to an innovative antifreeze circuit
- With filter change indicator, easy filter replacement
- Flexible arrangement (vertical and horizontal installation possible)

Ceiling installation in storage room

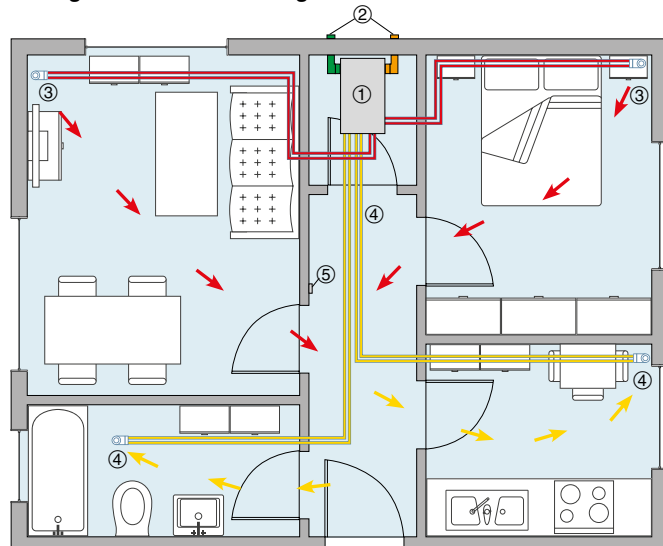

- ① Ventilation unit
- ② Outside air and outgoing air cowl
- ③ Supply air duct with valve
- ④ Exhaust air duct with valve
- ⑤ Control element

■ Supply air ■ Exhaust air ■ Outside air ■ Outgoing air

WS 75 Powerbox S

for residential units up to approx. 60 m²

MATERIAL PER RESIDENTIAL UNIT (example)

VARIANT / UNIT INSTALLATION IN STORAGE ROOMS OR IN SUSPENDED CEILINGS		ART. NO.
Ventilation unit including control element Installation on standard flush-mounted box Control via cable	WS 75 Powerbox S	0095.0645



Accessories for supply and exhaust air	ART. NO.	QUANTITY
① Disk valve for supply and exhaust air, TK 12	0151.0198	3
② Elbow, 90°, MA-U2-75 coupling	0059.2117	4
③ DN 75 flexible duct	0055.0096	2
④ Exhaust air valve with grease filter, DAE 125	0044.0203	1
⑤ Duct clamps	0018.0470	15



INDIVIDUAL COMPONENTS FOR THE OUTSIDE AND OUTGOING AIR FLOW WITH INSULATED DN 125 DUCT	ART. NO.	QUANTITY
① KW-AL 16 E outside air wall connection	0152.0077	1
② KW-FL 16 E outgoing air wall connection	0152.0079	1
③ L-duct, insulated, MT-R 125 (piece = 2 m)	0059.0981	1
④ Elbow, insulated, MT-B 125 90/45	0059.0983	2
⑤ Connector, MT-V 125	0059.0985	2
⑥ Ventilation duct coupling, MT-Üa 125	0059.0987	2



WS 120 Trio

Centralised ventilation of flats with heat recovery



MODE OF OPERATION

- Installation of the unit possible in any position, in suspended ceilings, in front walls or on roof slopes
- Four variants provide optimum connection conditions for ventilation ducts
- WS 120 Trio variants are optionally equipped with a preheating register for more comfort
- Control via 4-step switch, home network, app or optionally via a touch panel or via touch panel or KNX

MAICO highlights

- Height only 21 cm
- Dimensions W x H x D: 600 x 210 x 1070 mm
- Enthalpy heat exchanger prevents dry room air
- No condensate accumulation, no condensate drain necessary
- Integrated humidity control
- Very quiet operation
- Connection sockets can be mounted at various points



Includes RLS 1 WR control panel



Option: RLS T2 WS with touchscreen

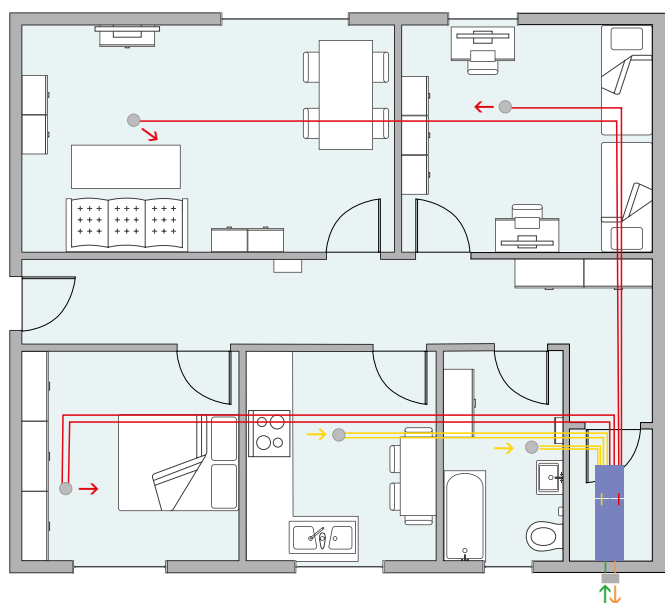

Left version WS 120 Trio LL with sound-insulation distributor for up to 6 DN 75 exhaust and supply air ducts each



sound insulation distributor
WS 120 Trio combination

Installation example of duct installation in concrete ceiling:

The ventilation units are mounted in a storage room.

■ Supply air ■ Exhaust air ■ Outside air ■ Outgoing air

WS 120 Trio

for residential units up to approx. 100 m²

If necessary, other positions can be selected for the sockets and/or the unit can be turned into the appropriate position. The illustrations show the units from above. The service side is at the bottom.

■ Supply air ■ Exhaust air ■ Outside air ■ Outgoing air

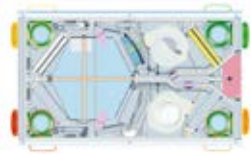

WS 120 Trio LL,
Left-hand version, longitudinal flow

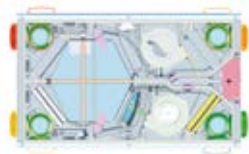

WS 120 Trio LR,
Right-hand version, longitudinal flow

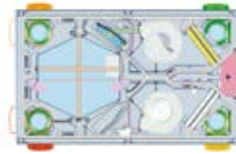

WS 120 Trio QL,
Left-hand version, cross-flow

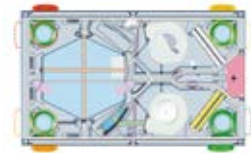

WS 120 Trio QR,
Right-hand version, cross-flow

MATERIAL PER RESIDENTIAL UNIT (example)

Ventilation unit with heat recovery incl. Trio control panel with energy-efficient EC motors	ART. NO.	QUANTITY
① WS 120 Trio LL	0095.0655	1
WS 120 Trio LR	0095.0657	optional
WS 120 Trio QL	0095.0659	optional
WS 120 Trio QR	0095.0661	optional

- Maximum 120 m³/h at 300 Pa



Combination sound insulation distributor	ART. NO.	QUANTITY
KSDV 125/12-75	0092.0586	1



Sound insulation distributor for supply or exhaust air. Facilitates installation in confined spaces

INDIVIDUAL COMPONENTS FOR SUPPLY AND EXHAUST AIR DN 90 FLEXIBLE DUCT	ART. NO.	QUANTITY
① Flexible duct, MF-F 75 (roll = 50 m)	0055.0096	1
② Gaskets, MF-FDR 75 (set = 10 pieces)	0175.0262	1
③ Deflection piece, MA-U2-75	0059.2117	5

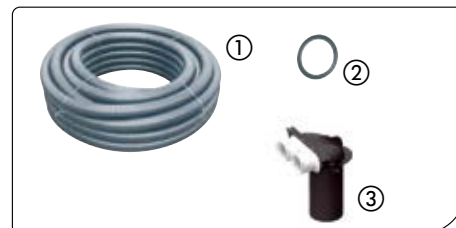

The MAICOFlex duct system – the optimal installation solution in terms of speed

MORE INDIVIDUAL COMPONENTS	ART. NO.	QUANTITY
① Disk valve for ventilation and air extraction, TK 12	0151.0198	4
② Exhaust air valve with grease filter for kitchen, DAE 125 E	0044.0203	1
③ Outside air wall connection, KW-AL-16W	0152.0078	1
④ Outgoing air wall connection, KW-FL-16W	0152.0080	1



MAICO accessories – suitable individual components

WS 160 Flat

Centralised ventilation of flats with heat recovery



Includes RLS 1
WR control panel



Option:
RLS T2 WS
with touchscreen



MODE OF OPERATION

- Installation of the unit possible in any position, in suspended ceilings, in front walls or on roof slopes
- Distribution of supply and exhaust air via MaicoFlex flexible ducting
- Outside/outgoing air via insulated MaicoTherm ducts
- Control via 4-step switch, home network, app or optionally, via touch panel or KNX

MAICO highlights

- Height only 23 cm
- Enthalpy heat exchanger prevents dry room air
- No condensate accumulation, no condensate drain necessary
- Can be installed in any position
- Left-/right-hand version in one unit
- Integrated humidity control
- Optional bypass, frost protection heating, zone control

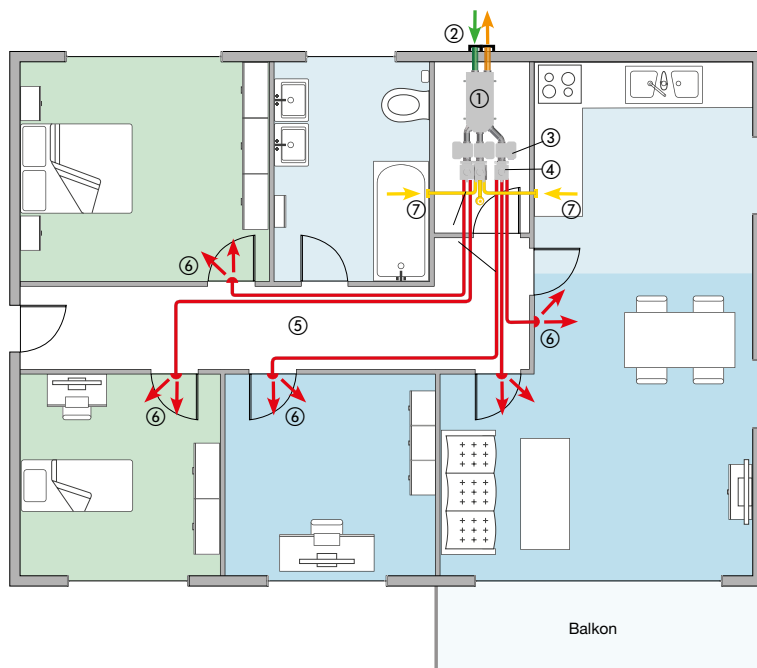
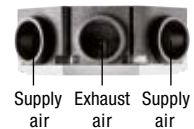

Air conduction w. patented zone control for supply air / zone 1 ■ zone 2 ■

Variant with patented zone control, WS 160 Flat KBZET

Different ventilation intensities can be achieved in the various rooms, e.g. during the day and at night

Variant without zone control, WS 160 Flat ET

Preset ventilation intensities are constant in the various rooms throughout the day

- ① WS 160 Flat KBZET ventilation unit
- ② KWH combination wall connection with MT-R thermal duct for outside and outgoing air
- ③ SB sound absorber box
- ④ MF-VK 90-7 air distributor for supply and exhaust air
- ⑤ MF-F 90 flexible duct
- ⑥ ZWQ 10 supply air valve with valve adapter
- ⑦ TK 10 exhaust air valve with valve adapter

■ Supply air ■ Exhaust air ■ Outside air ■ Outgoing air

WS 160 Flat

for residential units up to approx. 140 m²

MATERIAL PER RESIDENTIAL UNIT (example)

Complete kit comprising:

VENTILATION UNIT WITH HEAT RECOVERY including control panel	ART. NO.	WITH ZONE REGULATION QUANTITY	WITHOUT ZONE REGULATION QUANTITY
① WS 160 FLAT KBZET Basic unit with basic equipment	0095.0094	1	
② WS 160 FLAT ET Basic unit with basic equipment	0095.0090		1

- Max. 160 m³/h at 220 Pa
- Dimensions W x H x D: 582 x 230 x 1260 mm



INDIVIDUAL COMPONENTS FOR THE OUTSIDE AND OUTGOING AIR FLOW WITH INSULATED DN 125 DUCT	ART. NO.	QUANTITY	QUANTITY
① L-duct, insulated, MT-R 125 (piece = 2 m)	0059.0981	1	1
② Elbow, insulated, MT-B 125 90/45	0059.0983	1	1
③ Connector, MT-V 125	0059.0985	13	8
④ Plug connector, SVR 125	0055.0183	4	4
⑤ Coupling, MT-Ü125	0059.0986	4	4
⑥ Combination wall connection for outside/outgoing air, right-hand version, KWH 16 R	0152.0060	1	1



MAICOTherm

INDIVIDUAL COMPONENTS FOR SUPPLY AND EXHAUST AIR DN 90 FLEXIBLE DUCT	ART. NO.	QUANTITY	QUANTITY
① Flexible duct, MF-F 90 (roll = 50 m)	0055.0095	1	1
② Air distributor, MF-VK 90-7 1 x 125 / 7 x DN 90	0059.0994	3	2
③ Connector, MF-FSM 90	0059.0975	1	1
④ Gaskets, MF-FDR 90 (Set = 10 pieces)	0175.0263	1	1
⑤ Valve adapter, MF-A 90	0059.0963	7	7
⑥ Bracket, MF-WLF 100/90	0018.0607	1	1



MAICOFlex

MORE INDIVIDUAL COMPONENTS	ART. NO.	QUANTITY	QUANTITY
① Sound absorber box, SB 12/16	0059.0995	3	2
② Supply air valve, ZWVQ 10	0152.0064	5	5
③ Exhaust air valve, TK 10	0151.0192	3	3
④ Grease filter for kitchen, FFE 10	0092.0506	1	1



MAICO accessories

WS 170

Centralised ventilation of flats with heat recovery



Includes RLS 1
WR control panel



Option:
RLS T2 WS
with touchscreen

@home
AIR

Modbus®

KNX

enocean



MODE OF OPERATION

- Installation of the unit in storage room, kitchenette or hall cupboard
- Distribution of supply and exhaust air via MaicoFlex flexible ducting
- Outside/outgoing air via insulated MaicoTherm ducts
- Control via 4-step switch, home network, app or optionally, via touch panel or KNX

MAICO highlights

- Very energy-efficient, certified by the Passive House Institute
- Very quiet
- Integrated: Humidity control
- Optional: Enthalpy heat exchanger to prevent excessively dry room air
- Optional: bypass, frost protection heating

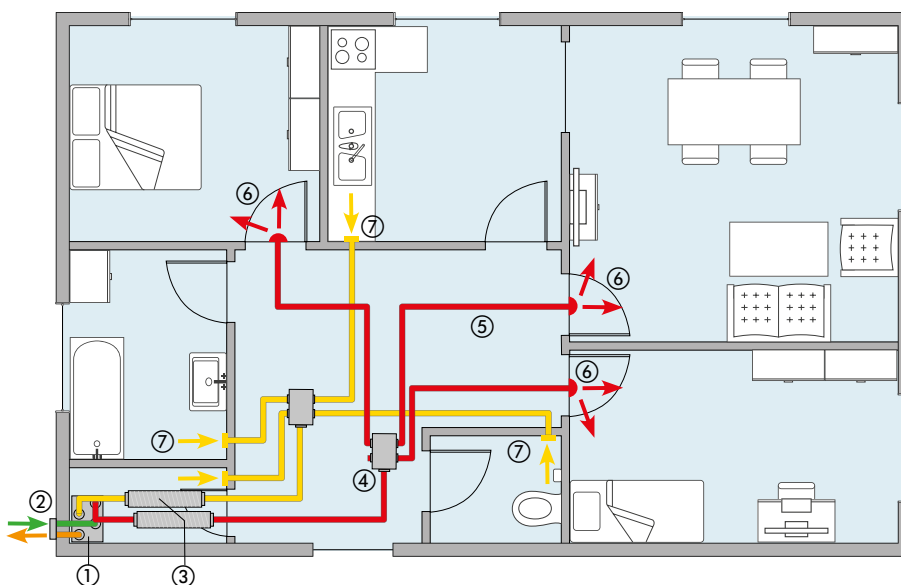

- ① WS 170 R ventilation unit
- ② KWH 16 L with connected MT-R thermal duct for outside and outgoing air
- ③ RSR 12-1 tubular sound absorber
- ④ MF-V 90 air distributors for supply and exhaust air
- ⑤ MF-F 90 flexible duct
- ⑥ ZWVQ 10 supply air valve
- ⑦ TK 10 exhaust air valve

■ Supply air ■ Exhaust air ■ Outside air ■ Outgoing air

WS 170

for residential units up to approx. 140 m²

MATERIAL PER RESIDENTIAL UNIT (example)

Complete kit comprising:

VENTILATION UNIT WITH HEAT RECOVERY including control panel	ART. NO.	QUANTITY
WS 170 R ① Supply and exhaust air connection on right (standard model)	0095.0081	1
optional: WS 170 L Supply and exhaust air connection on left	0095.0082	optional

- Max. 160 m³/h at 100 Pa
- Dimensions W x H x D: 595 x 820 x 375 mm



INDIVIDUAL COMPONENTS FOR THE OUTSIDE AND OUTGOING AIR FLOW WITH INSULATED DN 125 DUCT	ART. NO.	QUANTITY
① L-duct, insulated, MT-R 125 (piece = 2 m)	0059.0981	6
② Elbow, insulated, MT-B 125 90/45	0059.0983	8
③ Connector, MT-V 125	0059.0985	16
④ Plug connector, SVR 125	0055.0183	4
⑤ Coupling, MT-Ü125	0059.0986	4



MAICOTherm – installation solution suited to tight situations

INDIVIDUAL COMPONENTS FOR SUPPLY AND EXHAUST AIR, DN 90 FLEXIBLE DUCT	ART. NO.	QUANTITY
① Flexible duct, MF-F 90 (roll = 50 m)	0055.0095	1
② MF-V90 air distributor 1 x 125 / 4 x DN 90	0059.0968	2
③ Connector, MF-FSM 90	0059.0975	1
④ Gaskets, MF-FDR 90 (Set = 10 pieces)	0175.0263	1
⑤ Valve adapter, MF-A 90	0059.0963	7



The MAICOFlex duct system – the optimal installation solution in terms of speed

MORE INDIVIDUAL COMPONENTS	ART. NO.	QUANTITY
① Tubular sound absorber, RSR 12-1	0092.0593	2
② Supply air valve, ZWVQ 10	0152.0064	3
③ Exhaust air valve, TK 10	0151.0192	4
④ Combination wall connection for outside/outgoing air, right-hand version, KWH 16 L	0152.0061	1
⑤ Grease filter for kitchen, FFE 10	0092.0506	1



MAICO accessories – suitable individual components

WS 300 Flat

Central ventilation with heat recovery for flats and detached houses



Includes RLS 1 WR control panel



Optional RLS T2 WS with touchscreen



Modbus®



MODE OF OPERATION

- Installation of the unit in a storage room, cellar or thermally insulated attic
- Distribution of supply and exhaust air via MAICOFlex flexible ducting
- Outside/outgoing air via MAICOTherm thermally insulated ducts
- Control via 4-step switch, home network, app or optionally, via touch panel or KNX

MAICO highlights

- Energy-saving ventilation unit with EC fans
- The flat design is also ideal for retrofitting
- Flexible choice of location thanks to enthalpy heat exchanger as no condensate drain is necessary
- Energy efficiency class A
- Optional: bypass, frost protection heating

- | | | |
|--|--------------------------------|---------------------|
| ① WS 300 Flat KBR ventilation unit mounted vertically on the exterior wall | ③ Outgoing air wall connection | ⑥ Duct system |
| ② Outside air wall connection | ④ Tubular sound absorber | ⑦ Supply air valve |
| | ⑤ Air distributor | ⑧ Exhaust air valve |

■ Supply air ■ Exhaust air ■ Outside air ■ Outgoing air

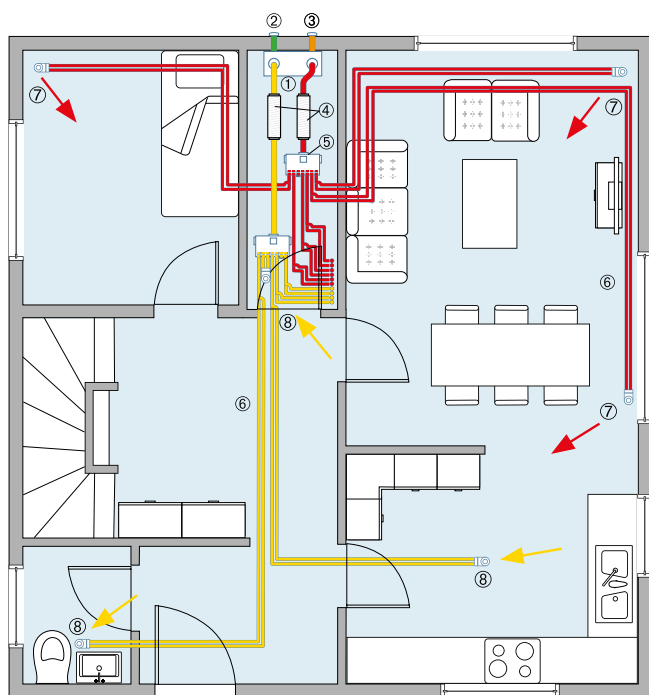

Ground floor

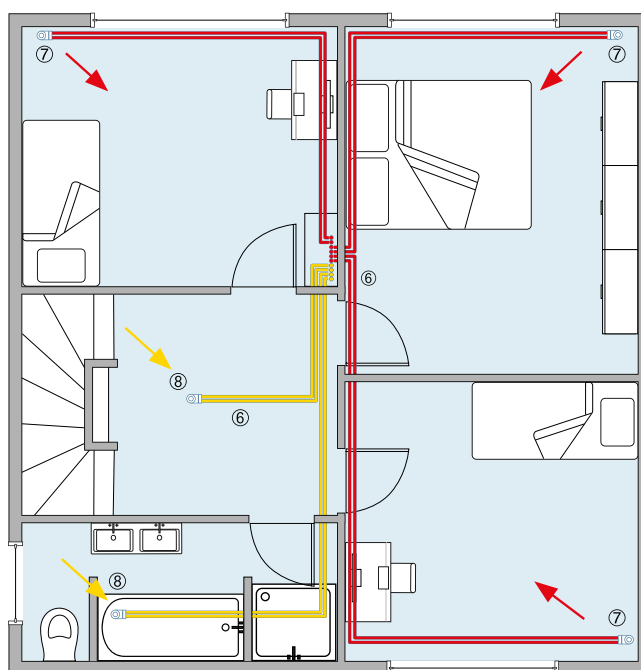

Upper floor

WS 300 Flat

for residential units up to approx. 300 m²

MATERIAL PER RESIDENTIAL UNIT (example)

Complete kit comprising:

VENTILATION UNIT WITH HEAT RECOVERY including control panel	ART. NO.	QUANTITY
① WS 300 Flat KBR	0095.0144	1

- Max. 300 m³/h at 475 Pa
- Dimensions W x H x D: 700 x 300 x 1500 mm



INDIVIDUAL COMPONENTS FOR THE OUTSIDE AND OUTGOING AIR FLOW WITH INSULATED DN 160 DUCT	ART. NO.	QUANTITY
① Duct, MT-R160 (item = 2 m)	0059.0982	2
② Elbow, MT-B125 90/45	0059.0983	5
③ Connector, MT-V160	0059.0988	10
④ Coupling, MT-Ü160/150	0059.0990	10
⑤ Plug connector, SVR 160	0055.0185	4

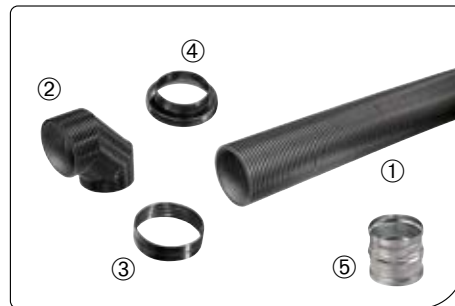

MAICOTherm – installation solution suited to tight situations

INDIVIDUAL COMPONENTS FOR SUPPLY AND EXHAUST AIR	ART. NO.	QUANTITY
① Plate distributor, MF-BV75-160-12	0018.0528	2
② Flexible duct, MF-F75 (roll = 50 m)	0055.0096	4
③ Sealing rings, MF-FDR75 (set = 10 pieces)	0175.0262	4
④ Deflection piece, MA-U2-75	0059.2117	11

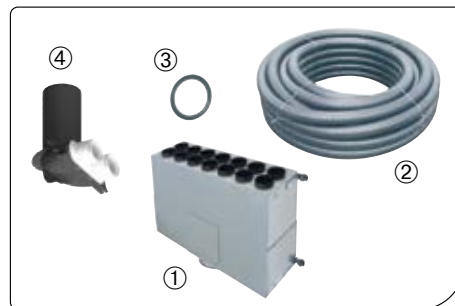

The MAICOFlex duct system – the optimal installation solution in terms of speed

MORE INDIVIDUAL COMPONENTS	ART. NO.	QUANTITY
① Tubular sound absorber, RSR 16/50-1	0092.0603	2
② Supply air valve, TFZ 12	0151.0365	6
③ Exhaust air valve, TFA 12	0151.0370	4
④ Mounting frame, EBR-D 12 for TFZ/TFA	0092.0494	10
⑤ Outside air wall connection, KW-AL 20 E	0152.0081	1
⑥ Outgoing air wall connection, KW-FL 20 E	0152.0083	1
⑦ Exhaust air valve with grease filter, DAE 125 E	0044.0203	1



MAICO accessories – suitable individual components

WS 320

Centralised ventilation of flats with heat recovery



Includes RLS 1 WR control panel



Optional RLS T2 WS with touchscreen



Central ventilation unit for flats and single-family homes up to approx. 250 m²

MODE OF OPERATION

- Installation of the unit in a storage room, cellar or insulated attic
- Distribution of supply and exhaust air via MaicoFlex flexible ducting
- Outside/outgoing air via insulated MaicoTherm ducts
- Control via 4-step switch, home network, app or optionally, via touch panel or KNX

MAICO highlights

- Very energy-efficient, certified by the Passive House Institute
- Very quiet
- Integrated: Humidity control
- Optional: Enthalpy heat exchanger to prevent excessively dry room air
- Optional: bypass, frost protection heating

- | | |
|---|----------------------------|
| ① WS 320 B ventilation unit | ⑤ MF-F63 flexible duct |
| ② KW-AL, KW-FL outside and outgoing air wall connection with MT-R thermal duct for outside and outgoing air | ⑥ TFZ 12 supply air valve |
| ③ RSR 16/50-1 tubular sound absorber | ⑦ TFA 12 exhaust air valve |
| ④ MF-BV63-160-14 air distributors for supply and exhaust air | |

■ Supply air ■ Exhaust air ■ Outside air ■ Outgoing air

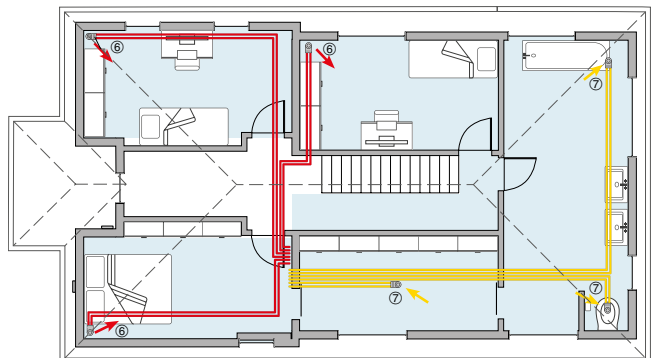
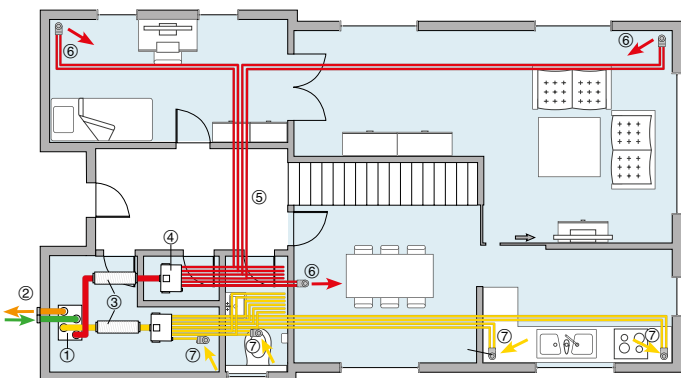

WS 320

for residential units up to approx. 300 m²

MATERIAL PER RESIDENTIAL UNIT (example)

Complete kit comprising:

VENTILATION UNIT WITH HEAT RECOVERY including control panel	ART. NO.	QUANTITY
① WS 320 B	0095.0221	1

- Max. 320 m³/h at 450 Pa
- Dimensions W x H x D: 841 x 857 x 598 mm



INDIVIDUAL COMPONENTS FOR THE OUTSIDE AND OUTGOING AIR FLOW WITH INSULATED DN 160 DUCT	ART. NO.	QUANTITY
① Duct, MT-R160 (item = 2 m)	0059.0982	5
② Elbow, MT-B160 90/45	0059.0984	8
③ Connector, MT-V160	0059.0988	15
④ Coupling, MT-Ů160/150	0059.0990	10
⑤ Plug connector, SVR 160	0055.0185	4

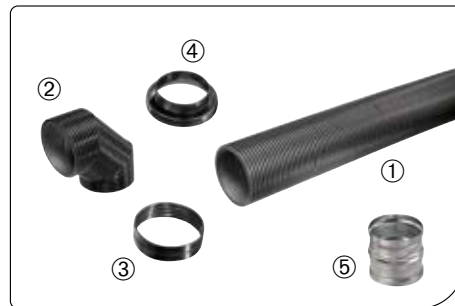

MAICOTherm – installation solution suited to tight situations

INDIVIDUAL COMPONENTS FOR SUPPLY AND EXHAUST AIR	ART. NO.	QUANTITY
① Plate distributor, MF-BV63-160-14	0018.0526	2
② Flexible duct, MF-F63 (roll = 50 m)	0055.0097	5
③ Sealing rings, MF-FDR63 (set = 10 pieces)	0175.0261	5
④ Deflection piece, MA-U3-63	0059.2116	13



The MAICOFlex duct system – the optimal installation solution in terms of speed

MORE INDIVIDUAL COMPONENTS	ART. NO.	QUANTITY
① Tubular sound absorber, RSR 16/50-1	0092.0603	2
② Supply air valve, TFZ 12	0151.0365	7
③ Exhaust air valve, TFA 12	0151.0370	5
④ Mounting frame, EBR-D 12 for TFZ/TFA	0092.0494	12
⑤ Outside air wall connection, KW-AL 20 E	0152.0081	1
⑥ Outgoing air wall connection, KW-FL 20 E	0152.0083	1
⑦ Exhaust air valve with grease filter, DAE 125 E	0044.0203	1



MAICO accessories – suitable individual components

WS 470

Central ventilation of flats and single-/two-family homes



WS 470 for single-family homes up to 450 m² Living space



MODE OF OPERATION

- Installation of the unit in the utility room, in a cellar or in a thermally insulated attic is also possible
- Distribution of supply and exhaust air via MAICOFlex flexible ducting
- Outside/outgoing air via MAICOTherm thermally insulated ducts
- Control via 4-step switch, home network, app or optionally, via touch panel or KNX

Innovative highlights

- Very energy-efficient unit, certified by the Passive House Institute
- Particularly quiet ventilation operation
- Integrated humidity control
- Optional: Enthalpy heat exchanger to prevent excessively dry air
- Optional: bypass, frost protection heating

- | | |
|---|---------------------|
| ① WS 470 KB ventilation unit | ⑤ Flexible duct |
| ② Outside and outgoing air connection with thermal duct | ⑥ Supply air valve |
| ③ Tubular sound absorber | ⑦ Exhaust air valve |
| ④ Air distributor | |

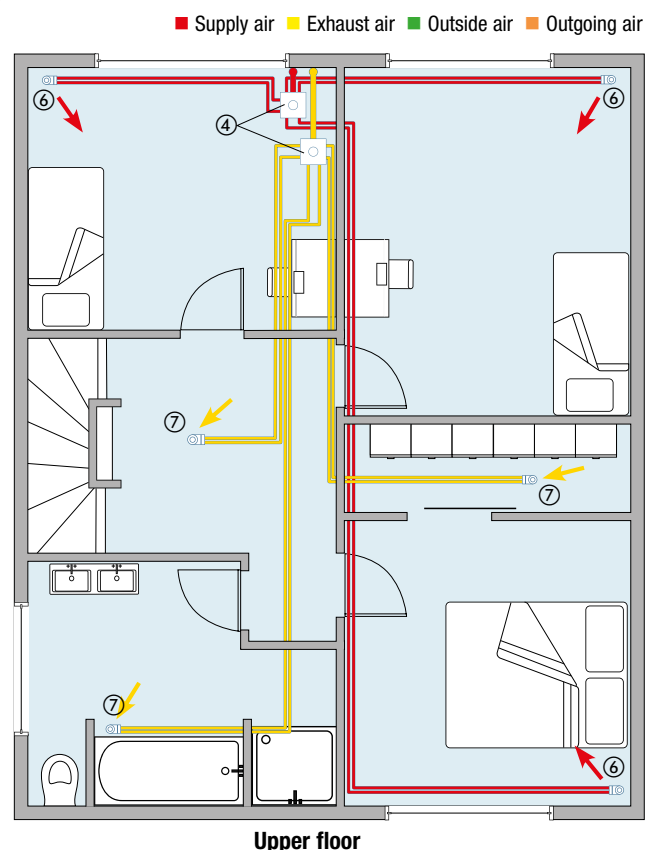
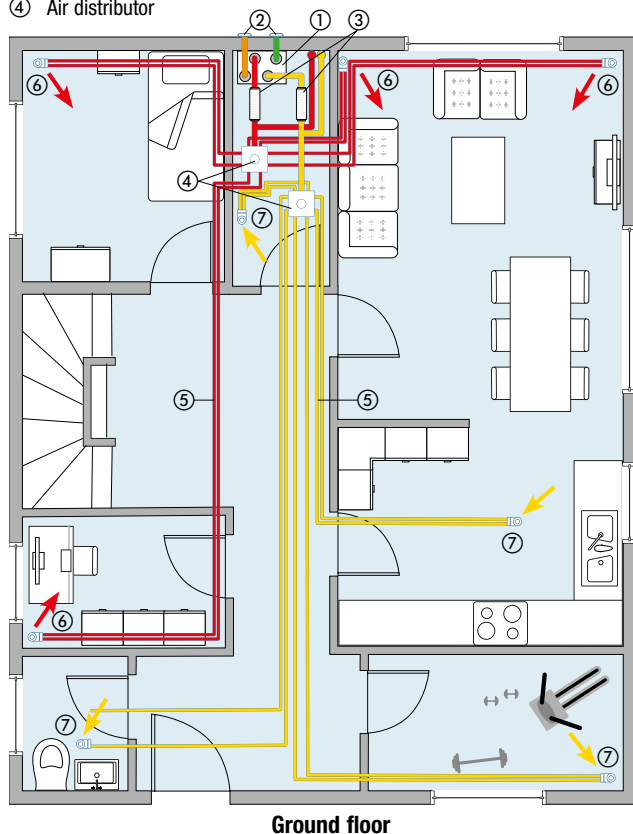

WS 470

for residential units up to approx. 450 m²

MATERIAL PER RESIDENTIAL UNIT (example)

Complete kit comprising:

VENTILATION UNIT WITH HEAT RECOVERY including control panel	ART. NO.	QUANTITY
① WS 470 KB with preheating register and bypass	0095.0231	1

- Max. 450 m³/h at 200 Pa
- Dimensions W x H x D: 841 x 857 x 598 mm

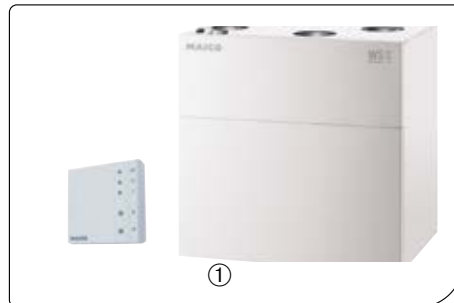

INDIVIDUAL COMPONENTS FOR THE OUTSIDE AND OUTGOING AIR FLOW WITH INSULATED DN 160 DUCT	ART. NO.	QUANTITY
① Duct, MT-R160 (item = 2 m)	0059.0982	4
② Elbow, MT-B160 90/45	0059.0984	8
③ Connector, MT-V160	0059.0988	17
④ Coupling, MT-Ü160/150	0059.0990	10
⑤ Plug connector, SVR 160	0055.0185	4

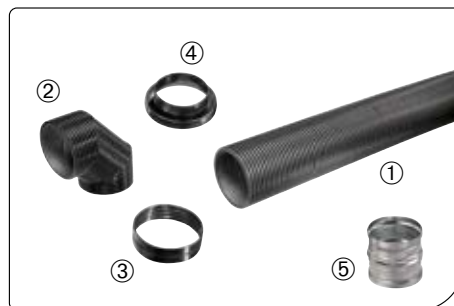

MAICOTherm – installation solution suited to tight situations

INDIVIDUAL COMPONENTS FOR SUPPLY AND EXHAUST AIR	ART. NO.	QUANTITY
① Plastic air distributor, MA-FV 8-75	0059.2125	4
② Flexible duct, MA-FR75 (roll = 50 m)	0152.0091	5
③ Deflection piece, MA-U2-75	0059.2117	14

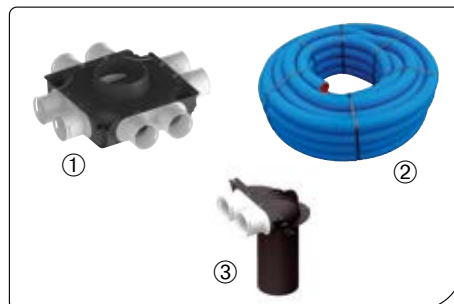

The MAICOFlex duct system – the optimal installation solution in terms of speed

MORE INDIVIDUAL COMPONENTS	ART. NO.	QUANTITY
① Tubular sound absorber, RSR 16/50-1	0092.0603	2
② Supply air valve, TFZ 12	0151.0365	7
③ Exhaust air valve, TFA 12	0151.0370	6
④ Mounting frame, EBR-D 12 for TFZ/TFA	0092.0494	13
⑤ Outside air wall connection, KW-AL 20 E	0152.0081	1
⑥ Outgoing air wall connection, KW-FL 20 E	0152.0083	1
⑦ Exhaust air valve with grease filter, DAE 125 E	0044.0203	1



MAICO accessories – suitable individual components

Systematically better ventilation

The right MAICO duct system for every need with hygienically smooth inner surface

MAICOFlex

The practical all-rounder duct system with the "click".

- Complete solution with distributors, ducts, adapters and various installation accessories.
- Available in the nominal sizes of 63, 75 and 90 mm.
- Suitable for both new buildings and redevelopments.



MAICOAir

Very flat compact design

- Only a few pluggable components are used for supply and exhaust air.
- Self-explanatory components – fast, almost tool-free installation.
- Available in the nominal sizes of 63, 75 and 90 mm
- Partially combinable with MAICOFlex ventilation duct system.
- All distributors, diverters and adapters are supplied with clamps and sealing rings.



MAICOTherm

The thermally insulated ventilation duct system that leaves nothing to chance

- It is particularly characterised by its ease of installation and universal use.
- Excellent heat and sound insulation properties.
- Available in the nominal sizes of 125 and 160 mm.

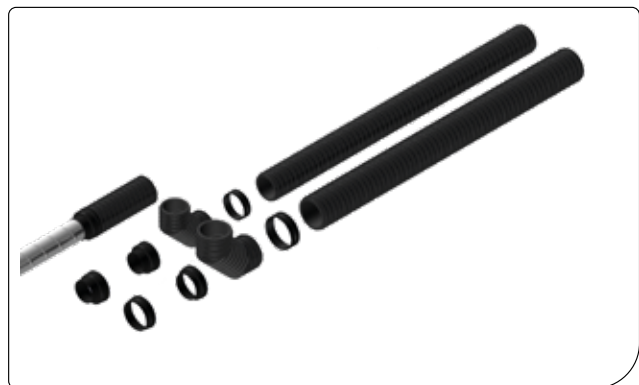

Maico Elektroapparate-Fabrik GmbH
Steinbeisstr. 20 · 78056 Villingen-Schwenningen/Germany
Phone +49 7720 694 255 · sales@maico.de
www.maico-ventilatoren.com