

WIRING DIAGRAM

AWP 150 S

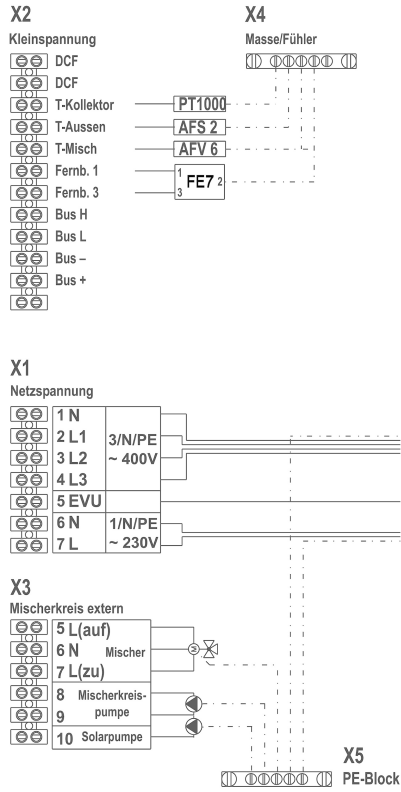

Wiring diagram for AWP ... and AWP ... S.



WIRING DIAGRAM

AWP 150 S

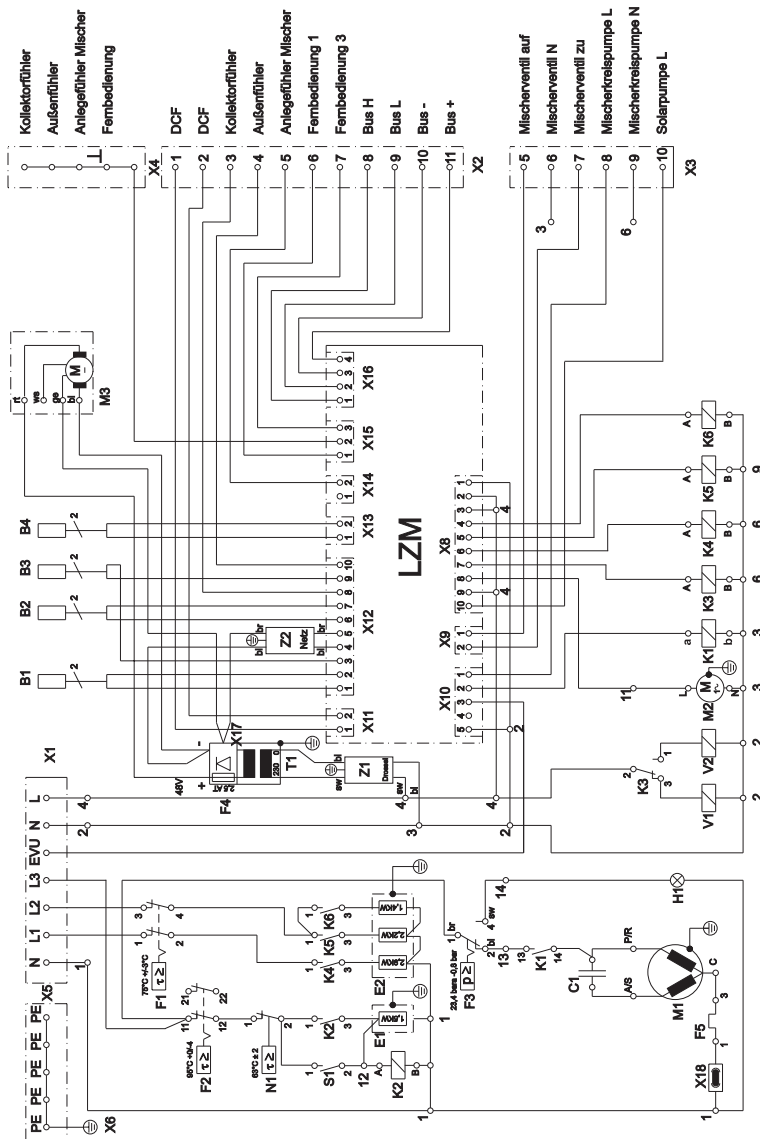

WIRING DIAGRAM



AWP 150 S

B1 - forward flow sensor
B2 - hot water sensor
B3 - return flow sensor
B4 - defrost sensor
C1 - operating capacitor
E1 - hot water heating element
E2 - heating system heating element
F1 - STB heating
F2 - STB hot water
F3 - pressure limiter
F4 - mains power unit protection
F5 - Klixon compressor
H1 - HD fault signal
K1 - compressor relay
K2 - hot water heating element relay
K3 - relay for switching between hot water and heating system
K4 - relay for heating step 3 of heating system
K5 - relay for heating step 2 of heating system
K6 - relay for heating step 1 of heating system
M1 - compressor.
M2 - circulation pump
M3 - exhaust fan
N1 - 65 C controller
S1 - electrical heating element sensor
T1 - mains power unit
V1 - heating system solenoid valve
V2 - hot water solenoid valve
X1 - mains connections
X2 - external extra-low voltage
X3 - external mixer circuit
Z1 - noise suppression device (throttle)
Z2 - noise suppression device (mains)
