

WIRING DIAGRAM

DZD35-4A

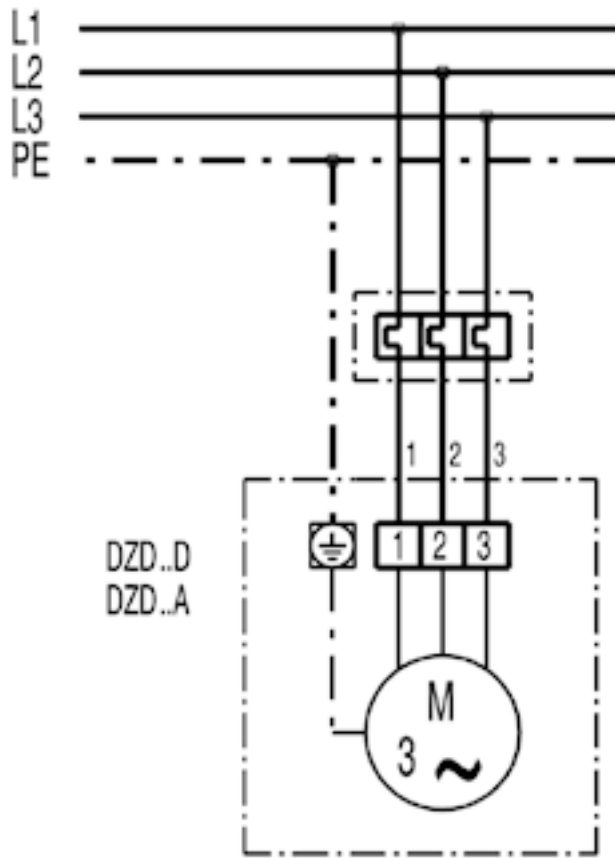

WIRING DIAGRAM

DZD35-4A

DZD...D with VE shutter, RKP and MS 8, MS 8 P servomotor

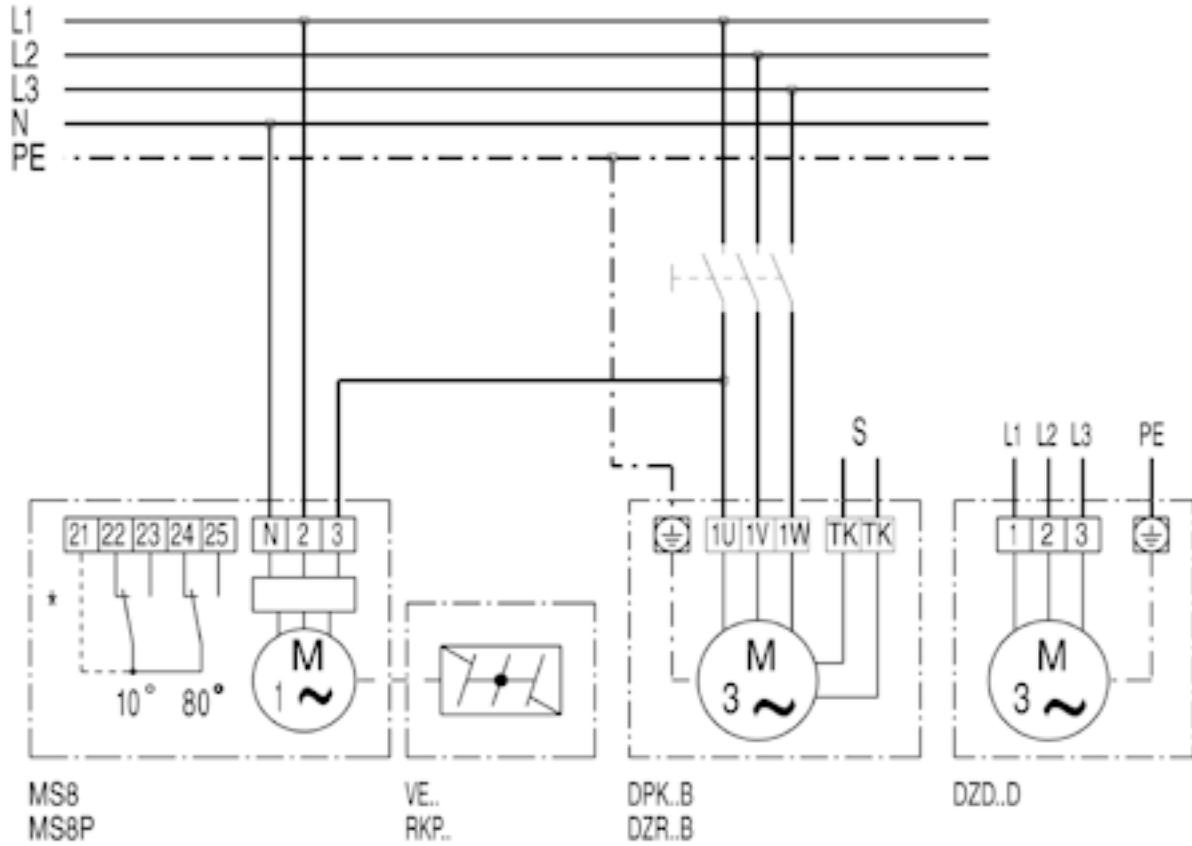

* Limit switch only for MS 8 P
S control circuit