

WIRING DIAGRAM

DZL 30/42 B

DZL...B pole-changeable (2 speeds, Dahlander circuit) with motor protection switch

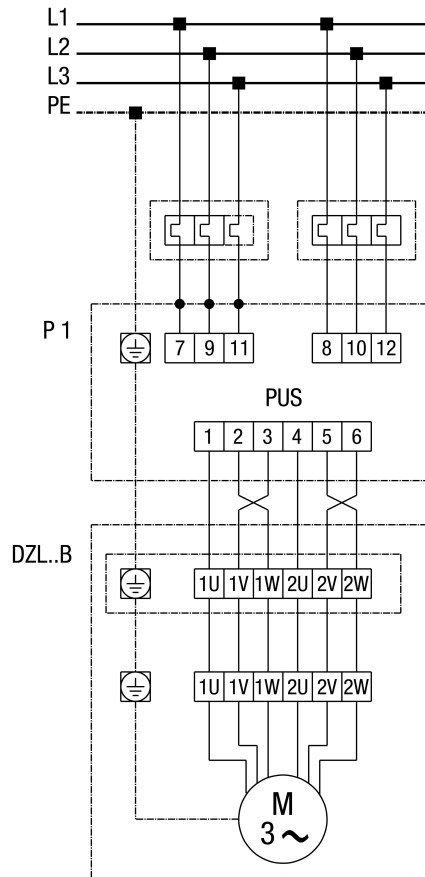

PUS - Pole-changing switch