

# WIRING DIAGRAM

## DZL 50/84 B

**DZL...B pole-changeable (2 speeds, Dahlander circuit) with motor protection switch**

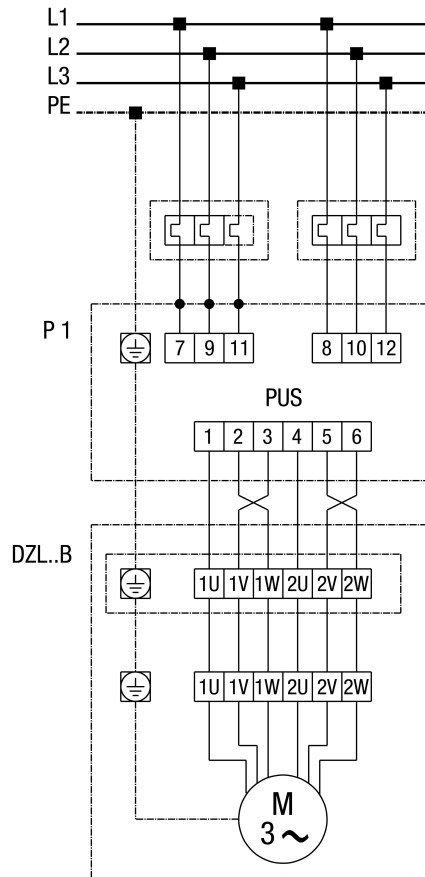

PUS - Pole-changing switch

---