

WIRING DIAGRAM

DZL 56/6 B

DZL...B standard (counter-clockwise, 1 speed)

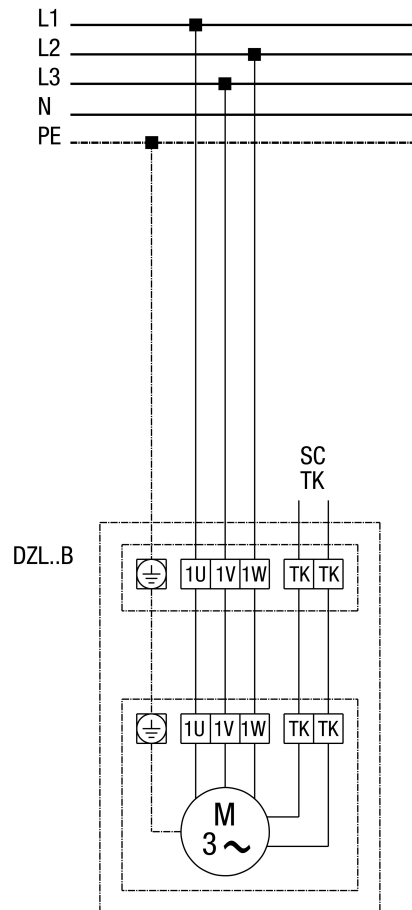

SC - Protection contact
TK - Thermal contact

WIRING DIAGRAM

DZL 56/6 B



DZL...B standard (anti-clockwise, 1 speed) with MV 25 full protection motor switch

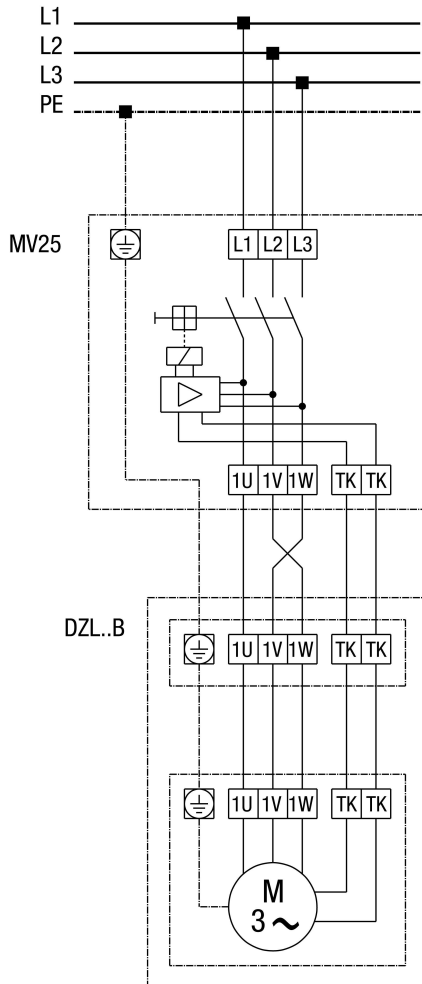

WIRING DIAGRAM

DZL 56/6 B

DZL...B standard (anti-clockwise, 1 speed) with TR... 5-step transformer and MV 25 full protection motor switch

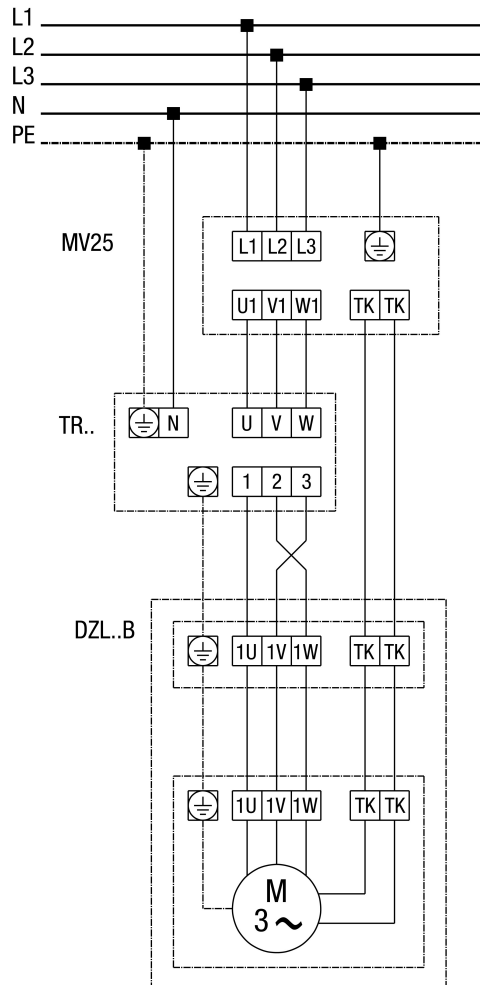

WIRING DIAGRAM

DZL 56/6 B



DZL... Standard (anti-clockwise, 1 speed) with TRV... 5-step transformer

