

WIRING DIAGRAM

DZR 40/2 B

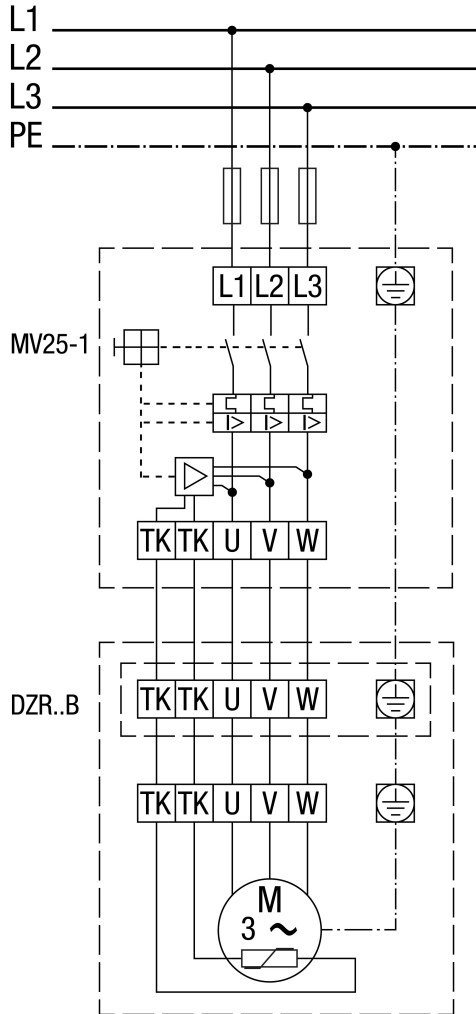

MV 25-1 motor protection switch



WIRING DIAGRAM

DZR 40/2 B



With MV 25-1 motor protection switch and TR... 5-step transformer

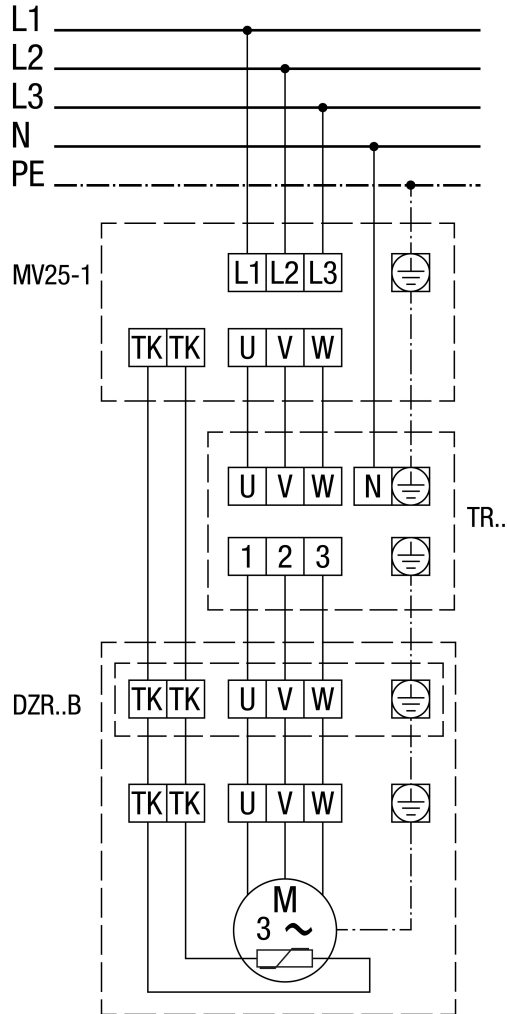

WIRING DIAGRAM

DZR 40/2 B



Pole-changeable, 2 speeds, with Dahlander circuit, with motor protection switch

