

WIRING DIAGRAM

ECR 25-2 EC

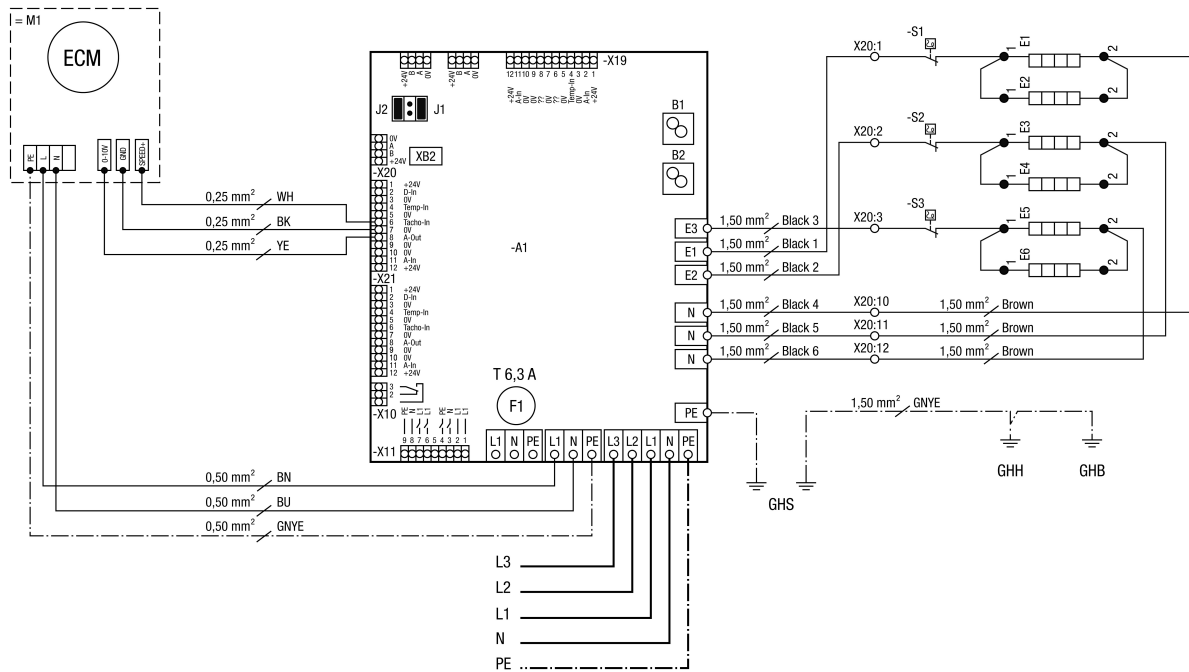

- M1 supply air fan
- J1 Termination BDT
- J2 Termination Modbus
- B1 Filter monitoring of supply air
- B2 Volumetric flow of supply air
- GHS housing Switch box
- GHH housing Heating
- GHB housing Box
- Power supply / 400V / 3- / N / 50Hz
- Fuse, external 16A