

WIRING DIAGRAM

ER-APB 60 VZ

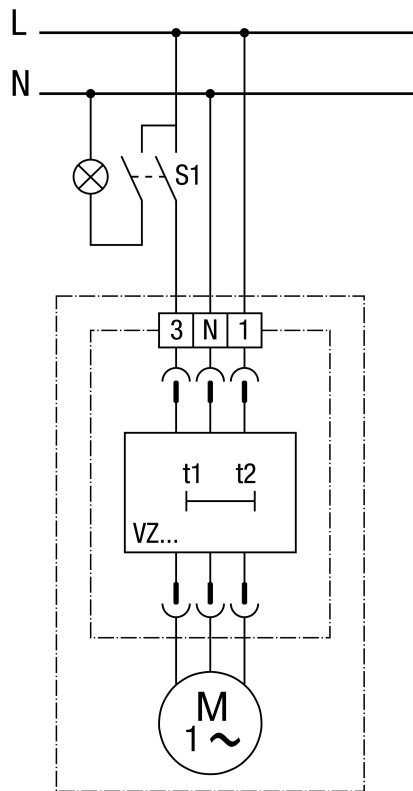

S1 on (after approx. 50 s)

S1 off (overrun time 6 min.)

Using a 1-pin switch can cause reverse polarity voltages. Combination with an X2 capacitor necessary!

WIRING DIAGRAM

ER-APB 60 VZ



Switching option 1

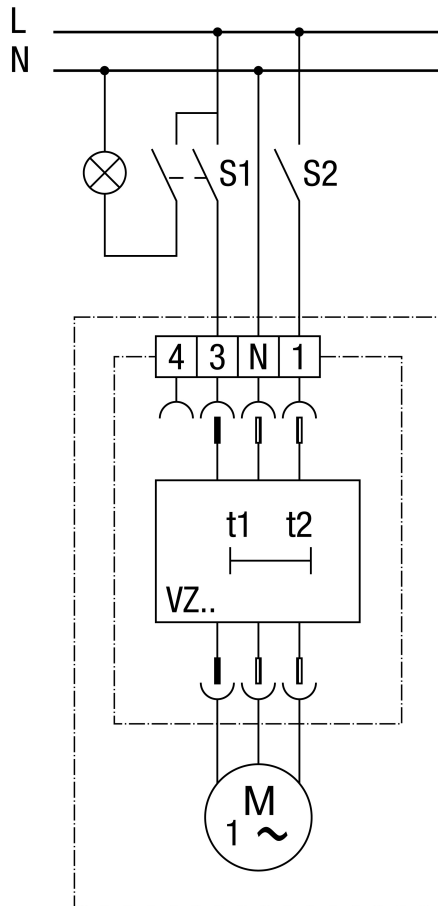

S1 and S2 on (after aprox. 50 s)

S1 off (overrun time 6 min.)

In addition, the fan can be switched off with switch S2 independent of the room lighting.

Using a 1-pin switch can cause reverse polarity voltages. Combination with an X2 capacitor necessary!

WIRING DIAGRAM

ER-APB 60 VZ



Switching option 2



S1 or S2 on (after aprox. 50 s)

S1 off (overrun time 6 min.)

The fan has an overrun time of approximately 6 minutes after switching off with the last switch to have been used.

① Main room

② Second room

Using a 1-pin switch can cause reverse polarity voltages. Combination with an X2 capacitor necessary!