

# WIRING DIAGRAM

## ER-AP 60 H

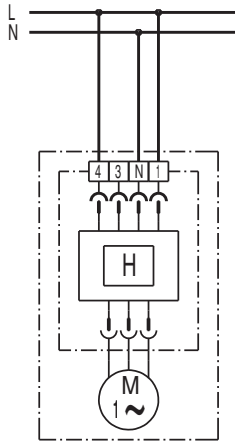

The fan always runs at the base load. If the humidity is higher than the switch-on humidity, the fan will automatically switch to full load.

---

# WIRING DIAGRAM

## ER-AP 60 H



### Switching option 1

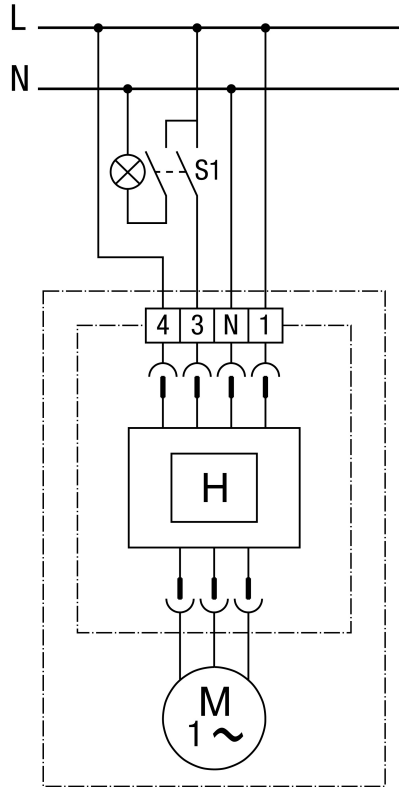

Fan always runs at base load. If humidity is higher than the switch-on humidity, the fan will automatically switch to full load. Additionally, it is possible to manually switch to full load with S1 switch.  
Using a 1-pin switch can cause reverse polarity voltages. Combination with an X2 capacitor necessary!

---

# WIRING DIAGRAM

## ER-AP 60 H



### Switching option 2



The fan is switched manually to base load with switch S1. If humidity is higher than the switch-on humidity, the fan will automatically switch to full load.

---

# WIRING DIAGRAM

## ER-AP 60 H



### Switching option 3



The fan is manually switched on and off with switch S1. The fan always overruns until the air humidity in the room has fallen below the switch-off humidity level.

---