

ERH... electric air heater with LW 9 air flow monitor and ST speed controller

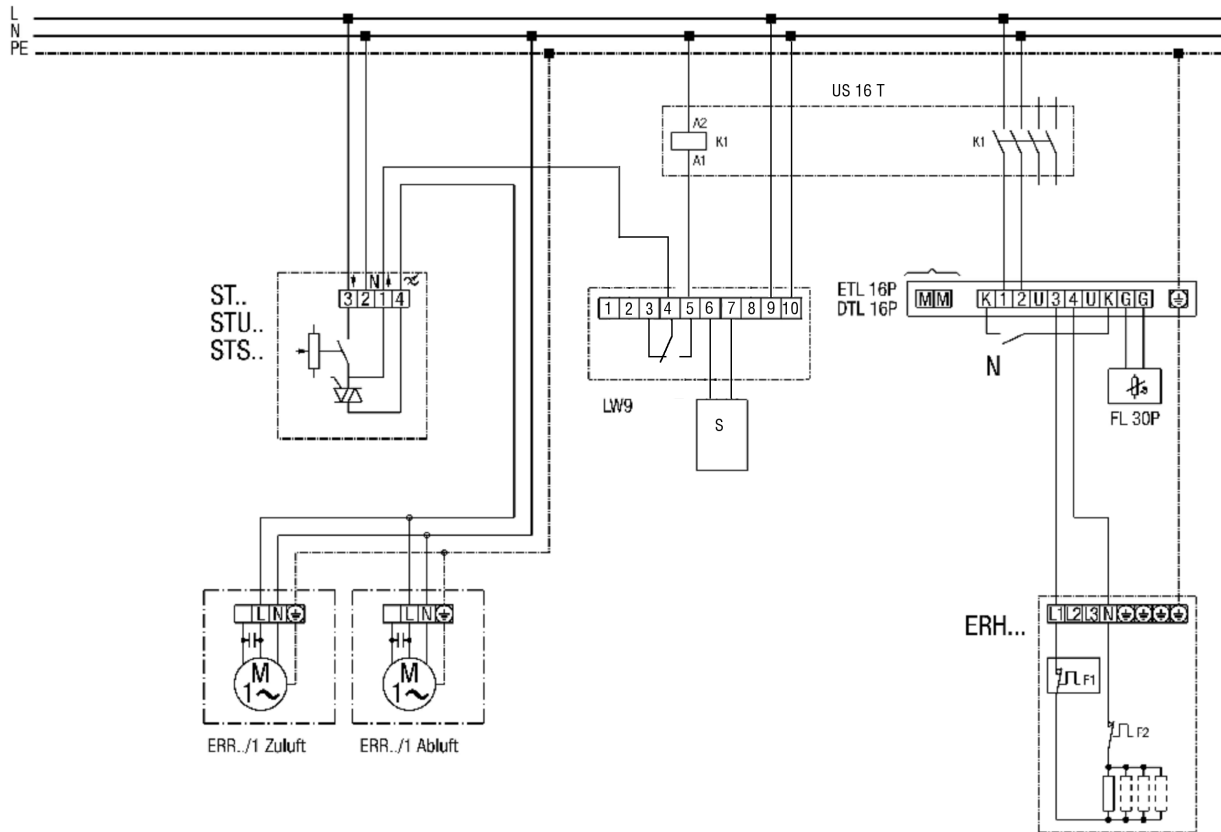

- K1 - heating release (US16T)
- ERR .. / 1 - centrifugal fan
- LW 9 - air flow monitor
- ETL 16 P - electronic temperature controller
- DTL 16 P - electronic temperature controller
- FL 30P channel sensor
- ST.. STU.., STS.. speed controller
- ERH - electric air heater
- F1 - temperature limiter
- F2 - safety temperature limiter
- N - night reduction
- ① Only with DTL 16 P

WIRING DIAGRAM

ERR 20/1



Centrifugal fan

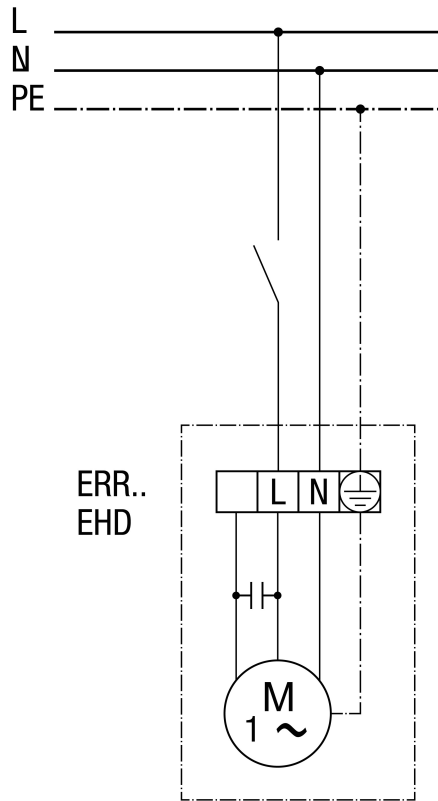

WIRING DIAGRAM

ERR 20/1

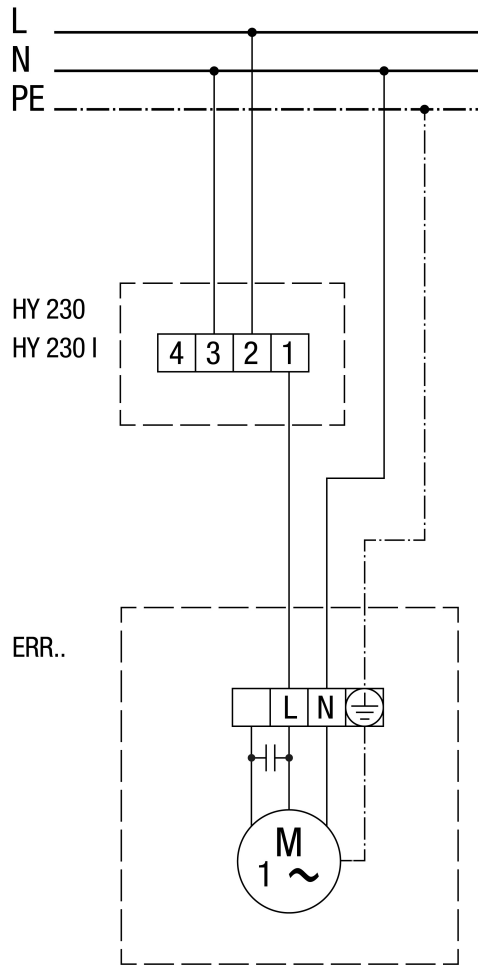

WIRING DIAGRAM

ERR 20/1



Centrifugal fan with ST/STU/STS speed controller

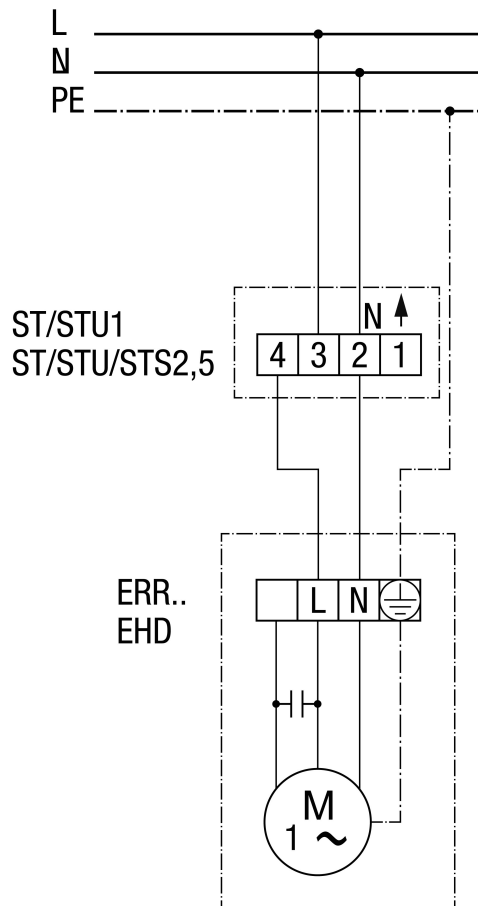

WIRING DIAGRAM

ERR 20/1

Centrifugal fan with TRE 5-step transformer

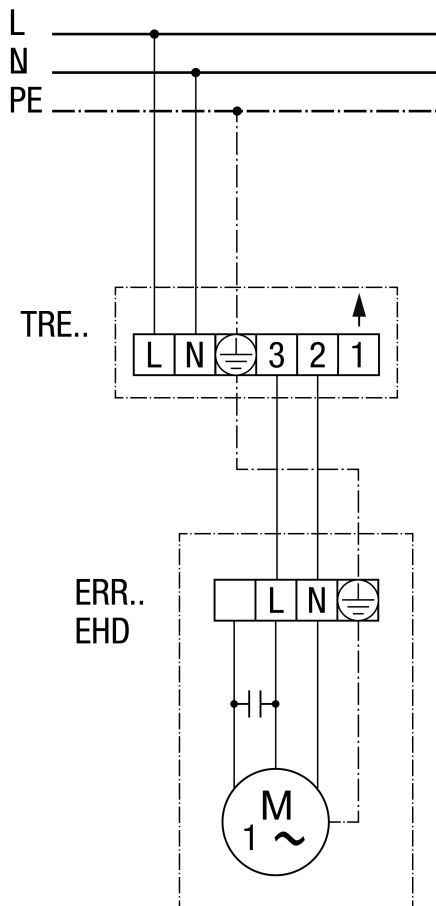

Duct fan with ERH 16-2 R electric air heater

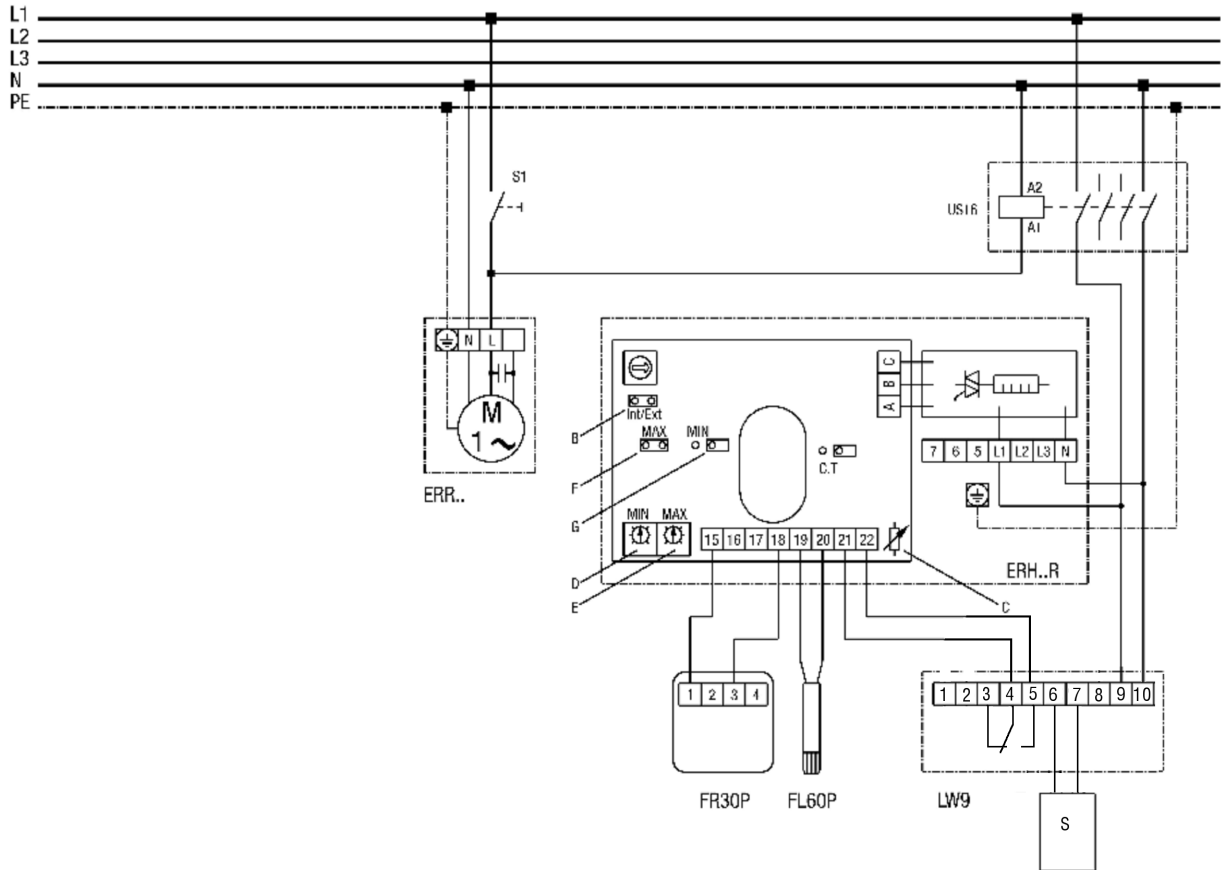

- S1 - system on
- US16 - all-pole isolating switch (contactor)
- ERR... centrifugal duct fan
- ERH...R electrical air heater: ERH16-2R
- B=Int/ext bridge must be closed
- C=Do not change potentiometer setting
- D=Setpoint potentiometer for MIN limitation
- E=Setpoint potentiometer for MAX limitation
- F=Bridge for MAX limitation, bridge must be closed!
- G=If bridge is closed, MIN limitation is also active
- FR30P - ext. setpoint controller (0-30°C) with room sensor
- FL30P - ext. channel sensor for MIN, MAX limitation
- LW9 - air flow monitor (in position N)
- Installation of LW9 sensor on incoming side of air heater
- 0-30°C setpoint setting and recording of room temperature with FR30P
- 0-60°C min/max limitation in supply air channel with FL60P

Duct fan with electric air heater DRH 16-5R and DRH 20-6R

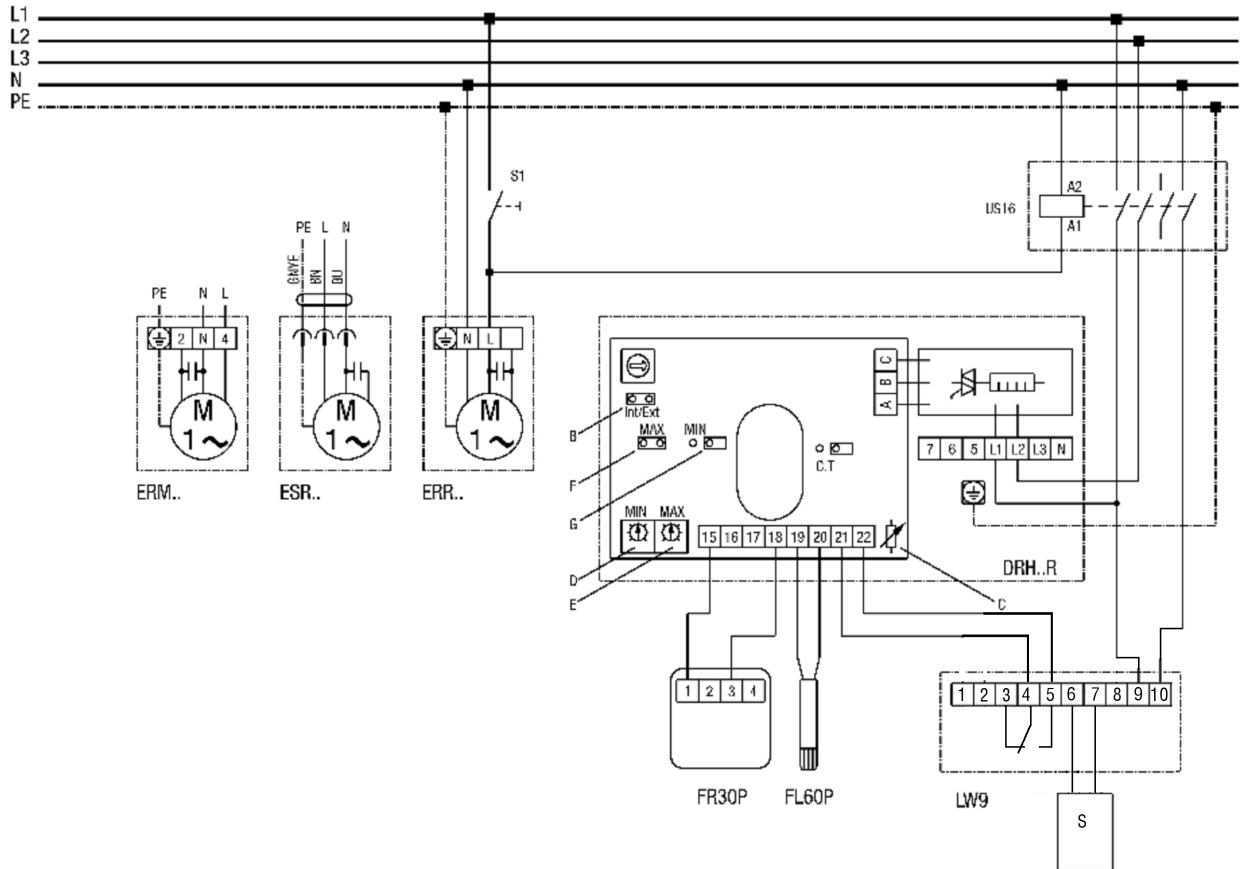

S1 - system on

US16 - all-pole isolating switch (contactor)

ERR... centrifugal duct fan

DRH...R electric air heater: DRH16-2R or DRH20-6R

B=Int/ext bridge must be closed

C=Do not change potentiometer setting

D=Setpoint potentiometer for MIN limitation

E=Setpoint potentiometer for MAX limitation

F=Bridge for MAX limitation, bridge must be closed!

G=If bridge is closed, MIN limitation is also active

FR30P - ext. setpoint controller (0-30°C) with room sensor

FL30P - ext. channel sensor for MIN, MAX limitation

LW9 - air flow monitor (in position N)

Installation of LW9 sensor on incoming side of air heater

0-30°C setpoint setting and recording of room temperature with FR30P

0-60°C min/max limitation in supply air channel with FL60P

Duct fan with DRH 25-9R, DRH 31-12R, DRH 35-12R and DRH 40-12R electric air heaters

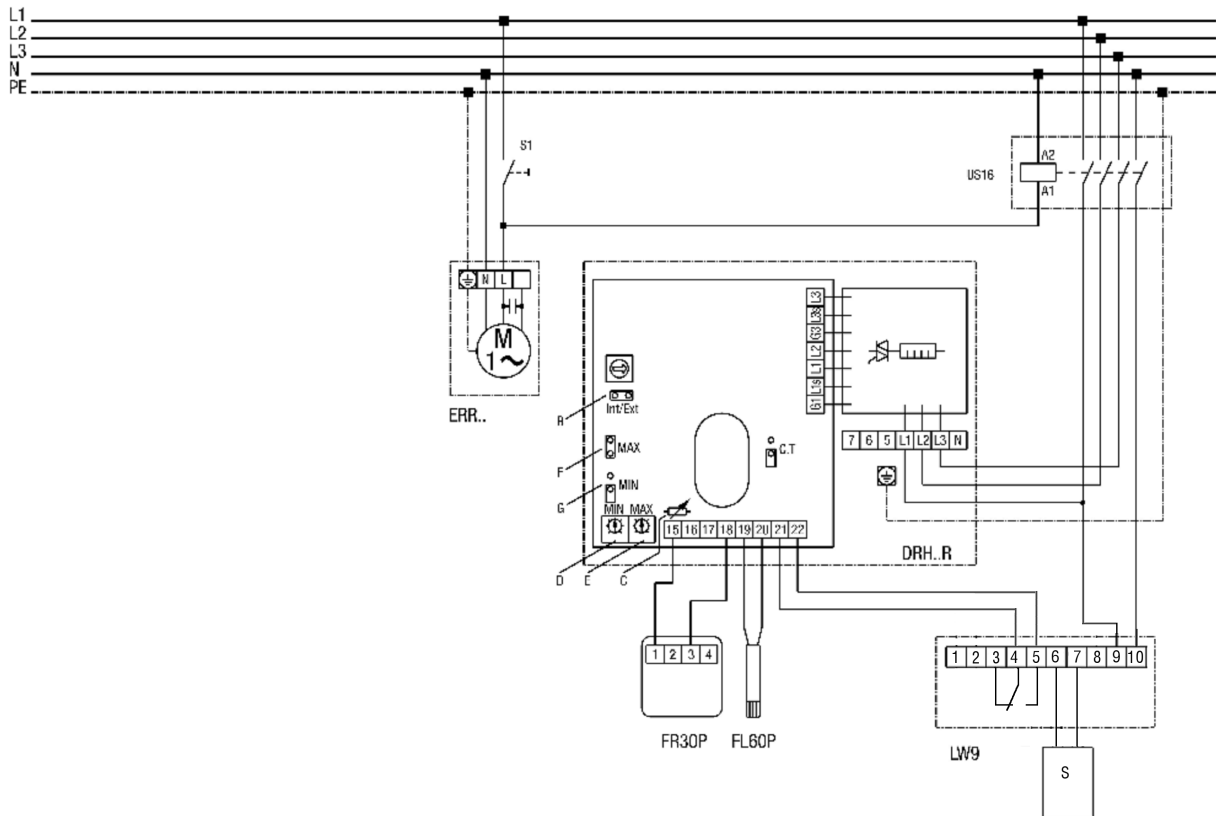

S1 - system on

S - sensor

US16 - all-pole isolating switch (contactor)

ERR... centrifugal duct fan

DRH...R electric air heater: DRH 25-9R, DRH 31-12R, DRH 35-12R, DRH 40-12R

B=Int/ext bridge must be closed

C=Do not change potentiometer setting

D=Setpoint potentiometer for MIN limitation

E=Setpoint potentiometer for MAX limitation

F=Bridge for MAX limitation, bridge must be closed!

G=If bridge is closed, MIN limitation is also active

FR30P - ext. setpoint controller (0-30°C) with room sensor

FL60P - ext. channel sensor for MIN, MAX limitation

LW9 - air flow monitor (in position N)

Installation of LW9 sensor on incoming side of air heater

0-30°C setpoint setting and recording of room temperature with FR30P

0-60°C min/max limitation in supply air channel with FL60P