

WIRING DIAGRAM

ER 60 GVZ

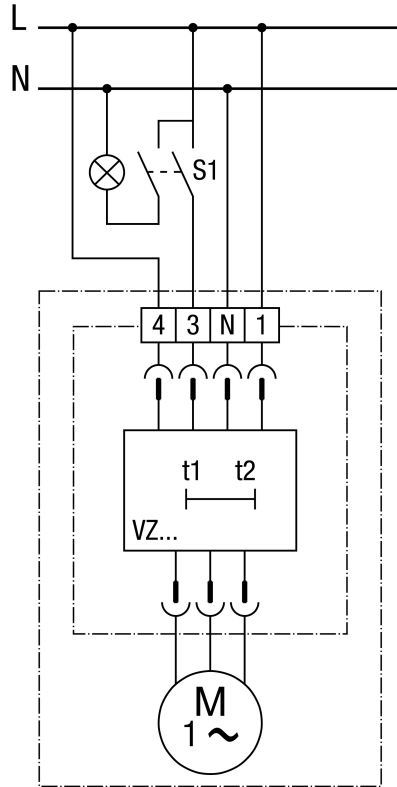

Standard switching:



Fan always runs at base load. When the room is in use (S1=On), the fan switches automatically to full load after approx. 50 seconds.

Using a 1-pin switch can cause reverse polarity voltages. Combination with an X2 capacitor necessary!

WIRING DIAGRAM

ER 60 GVZ



Switching option

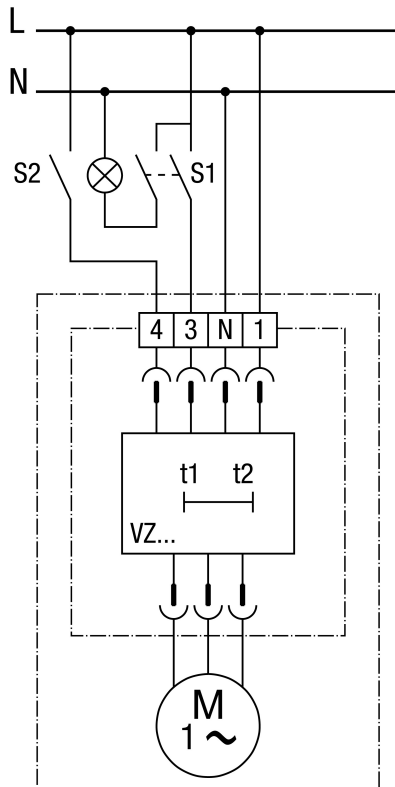

When the room is in use (S1=On), the fan switches automatically to full load after approx. 50 seconds. Base load operation can be switched off manually with switch S2.
Using a 1-pin switch can cause reverse polarity voltages. Combination with an X2 capacitor necessary!
