

WIRING DIAGRAM

ER 60 VZ 15

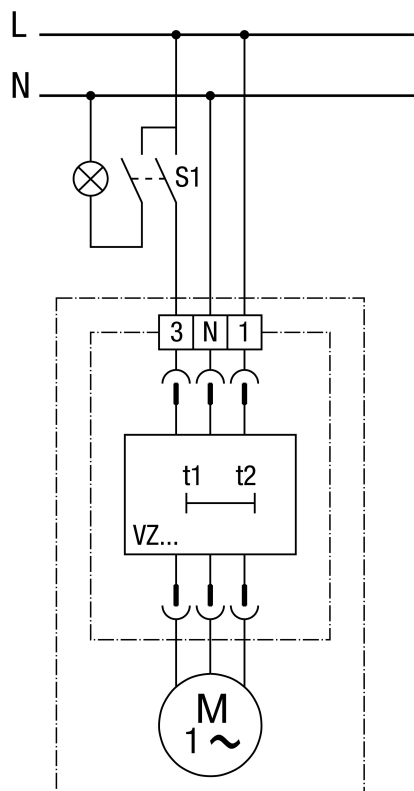

S1 on (after aprox. 50 s)

S1 off (overrun time 15 min.)

Using a 1-pin switch can cause reverse polarity voltages. Combination with an X2 capacitor necessary!

WIRING DIAGRAM

ER 60 VZ 15



Switching option 1



S1 and S2 on (after aprox. 50 s)

S1 off (overrun time 15 min.)

In addition, the fan can be switched off with switch S2 independent of the room lighting.

Using a 1-pin switch can cause reverse polarity voltages. Combination with an X2 capacitor necessary!

WIRING DIAGRAM

ER 60 VZ 15



Switching option 2

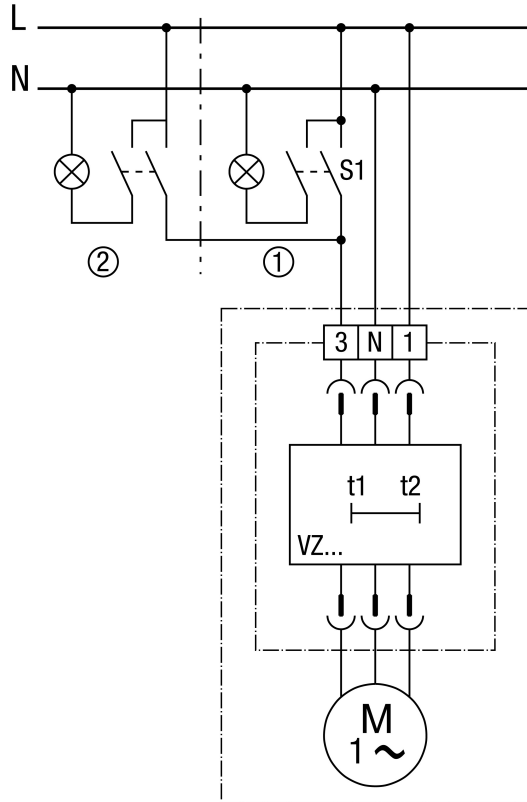

S1 or S2 on (after aprox. 50 s)

S1 off (overrun time 15 min.)

The fan has an overrun time of approximately 15 minutes after switching off with the last switch to have been used.

① Main room

② Second room

Using a 1-pin switch can cause reverse polarity voltages. Combination with an X2 capacitor necessary!