

ETR 25

ETR 25 with STW 1 speed controller or FS 6/7 step switch

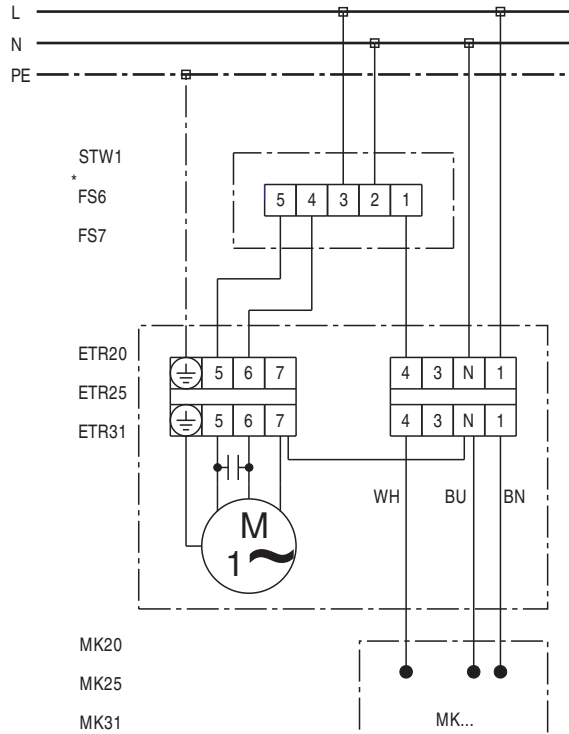

FS 6 not for ETR 31

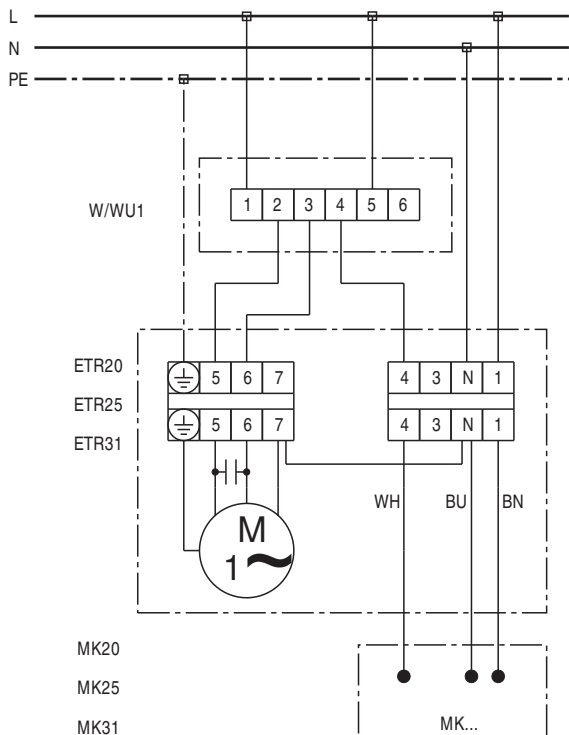

WIRING DIAGRAM

ETR 25

