

ETR 31

ETR 31 with STW 1 speed controller or FS 6/7 step switch

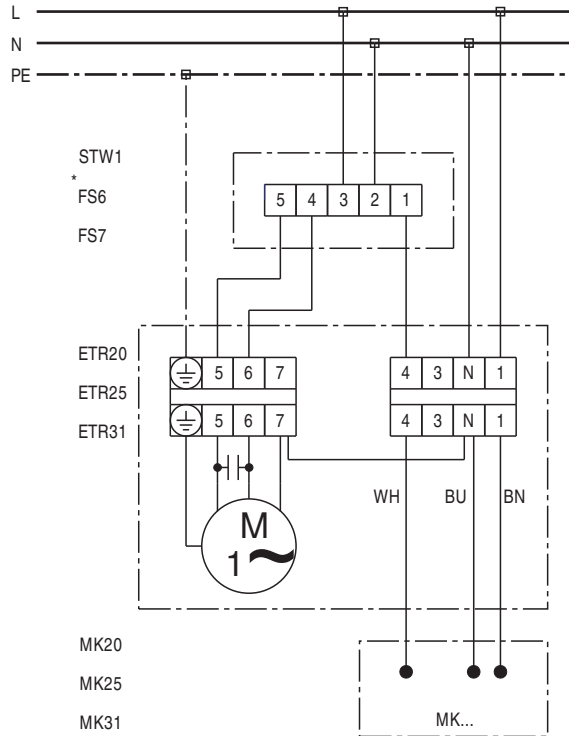

FS 6 not for ETR 31

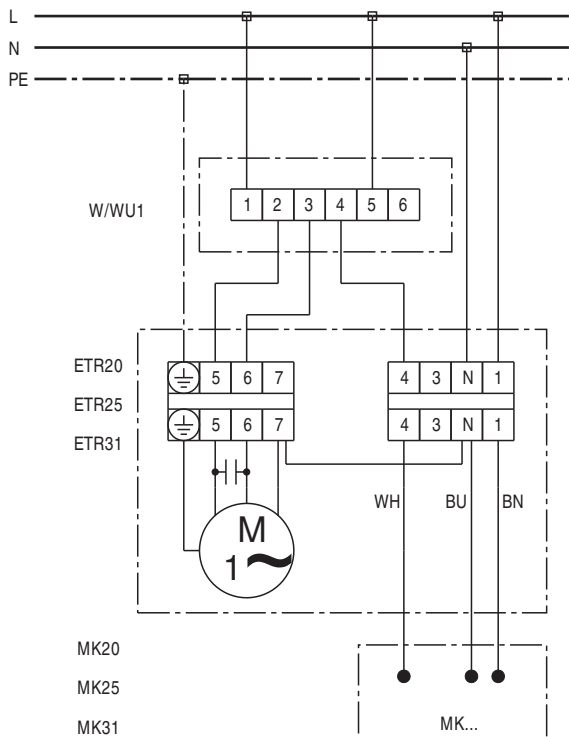

WIRING DIAGRAM

ETR 31

