

WIRING DIAGRAM

EZD30-4A

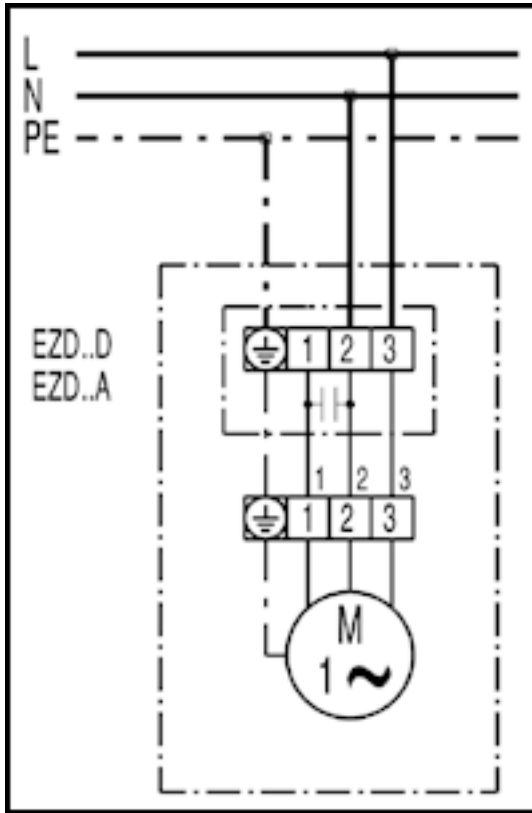

EZD...D for ventilation



Right-hand rotation: EZD...D with air drawn across the motor

WIRING DIAGRAM

EZD30-4A



EZD...D for air extraction

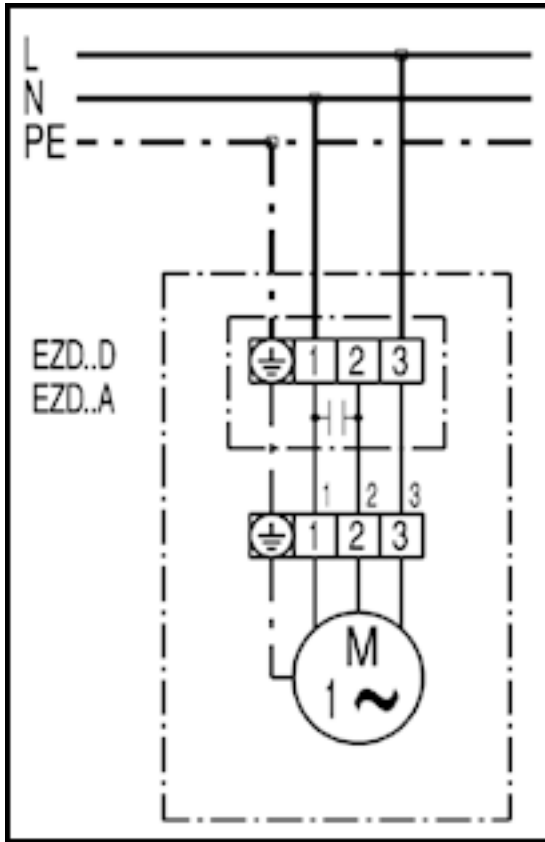

Right-hand rotation: EZD...D with air blown across the motor

WIRING DIAGRAM

EZD30-4A

EZD...D with VE shutter, RKP and MS 8, MS 8 P servomotor

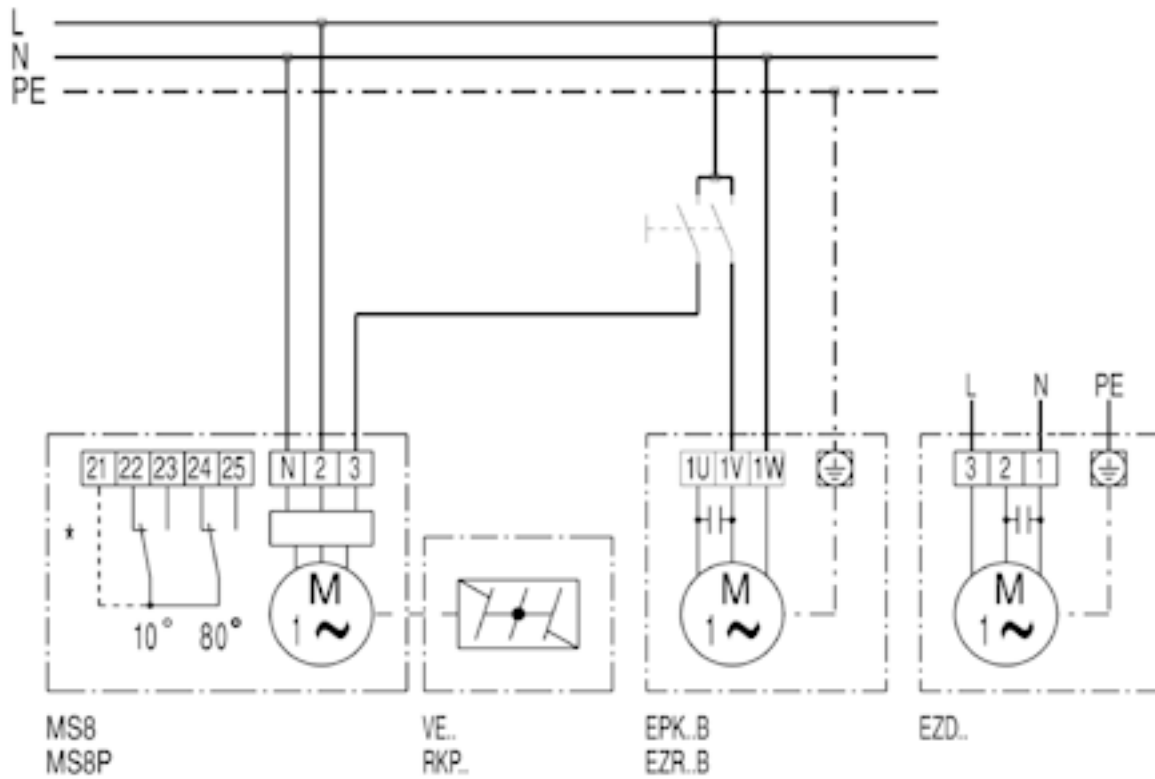

* Limit switch only for MS 8 P

WIRING DIAGRAM

EZD30-4A



EZD... with VE shutter, RKP and ST, STU, STS speed controller

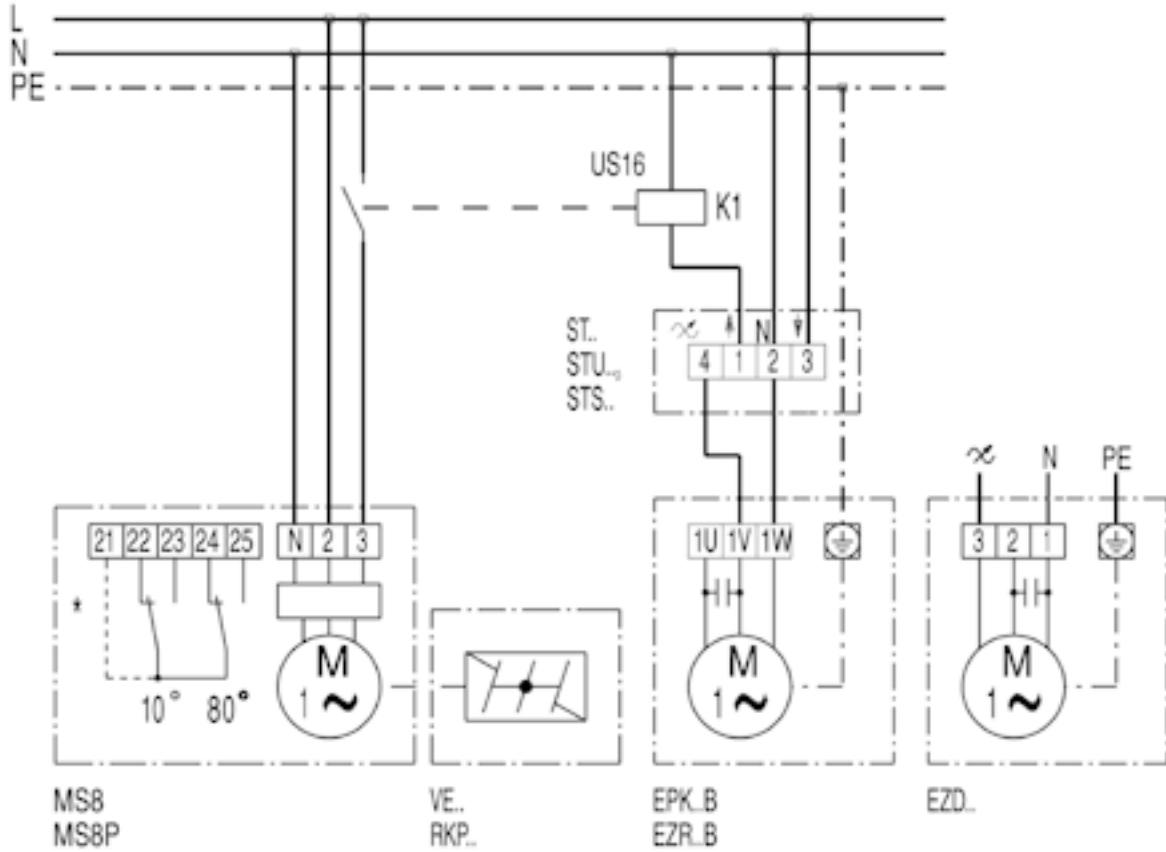

* Limit switch only for MS 8 P