

WIRING DIAGRAM

EZQ 20/2 B

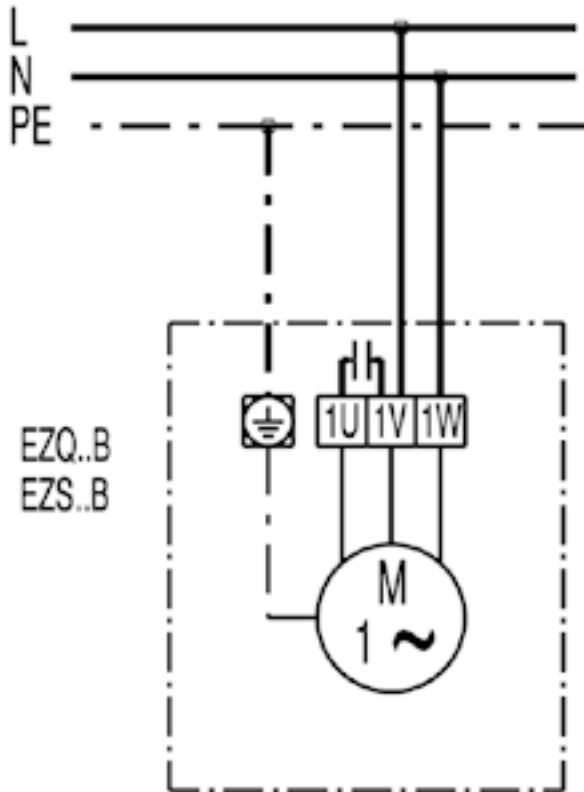

EZQ / EZS..B clockwise



WIRING DIAGRAM

EZQ 20/2 B



EZQ / EZS..B anti-clockwise

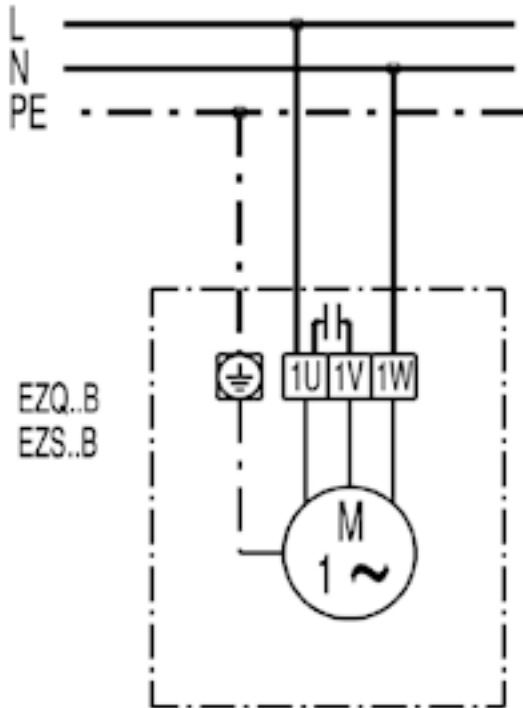

WIRING DIAGRAM

EZQ 20/2 B

EZQ / EZS..B with ST / STU / STS speed controller anti-clockwise

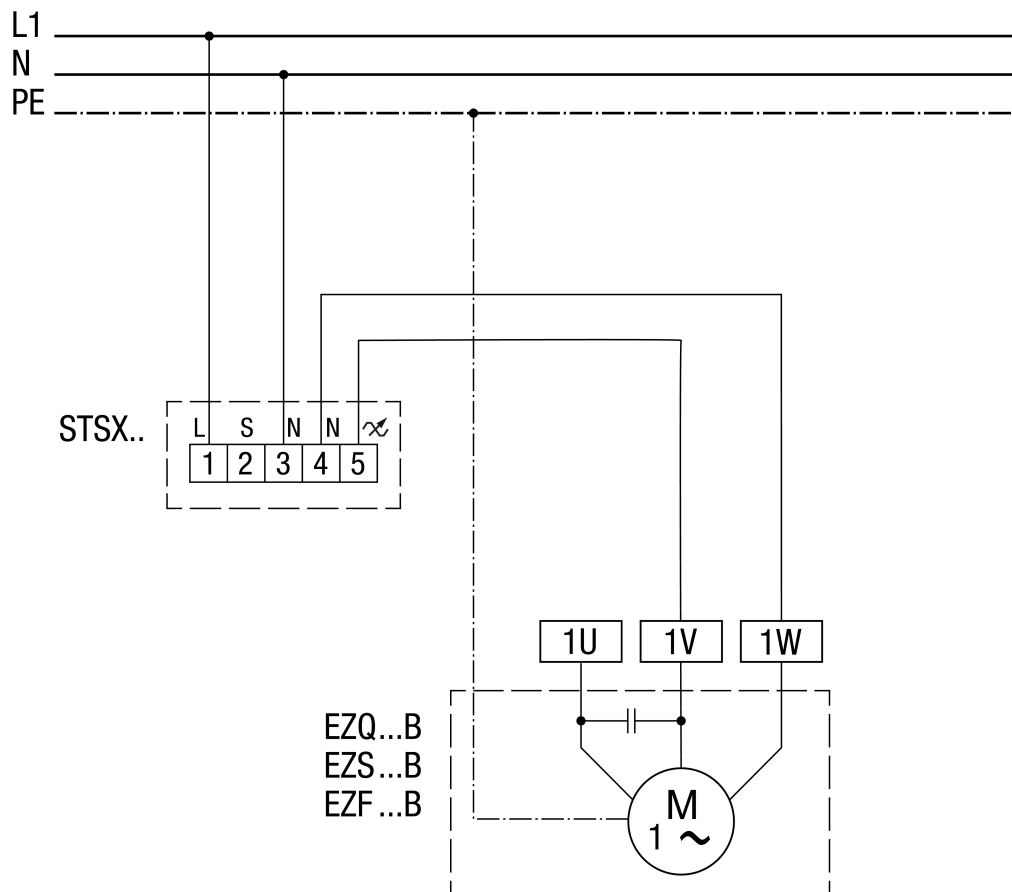

WIRING DIAGRAM

EZQ 20/2 B

EZQ / EZS..B with STW1 speed controller

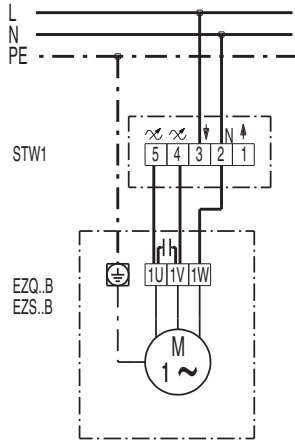

EZQ / EZS..B with UKW 1 reversing switch and STU.. speed controller

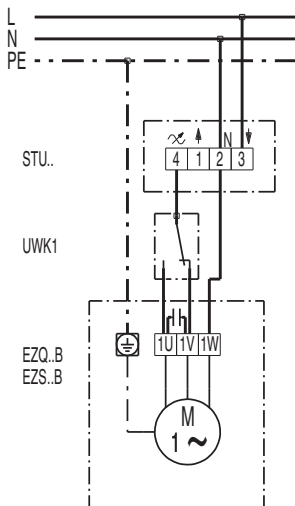

WIRING DIAGRAM

EZQ 20/2 B

EZQ / EZS..B with TRE..S / Tr..S 5-step transformer and ESS20 5-step switch

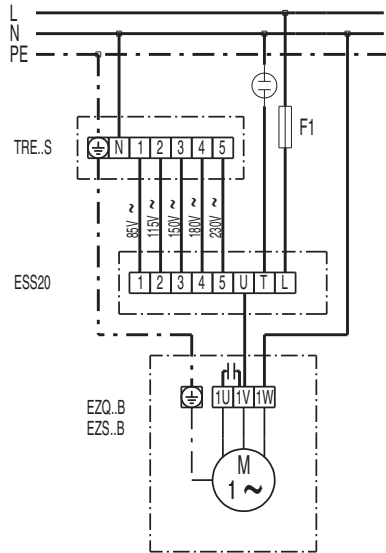

EZQ / EZS..B with TRE.. 5-step transformer

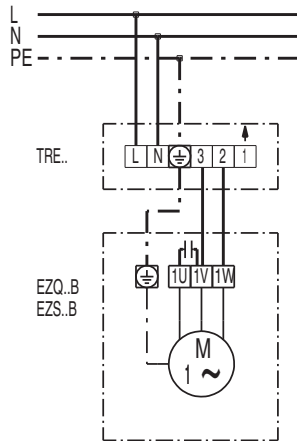

WIRING DIAGRAM

EZQ 20/2 B

EZQ / EZS..B with W1 / WU1 reversing switch

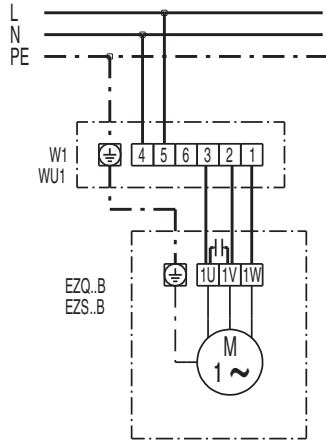

EZQ / EZS..B with FS 7 reversing switch

