

# WIRING DIAGRAM

## HDR 12 EC

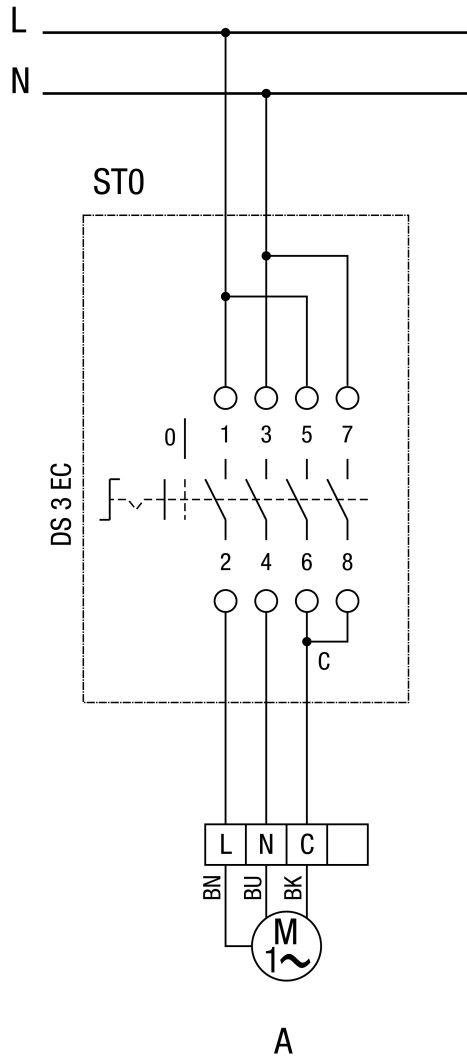

ST0 = position 0  
A = Off

# WIRING DIAGRAM

## HDR 12 EC

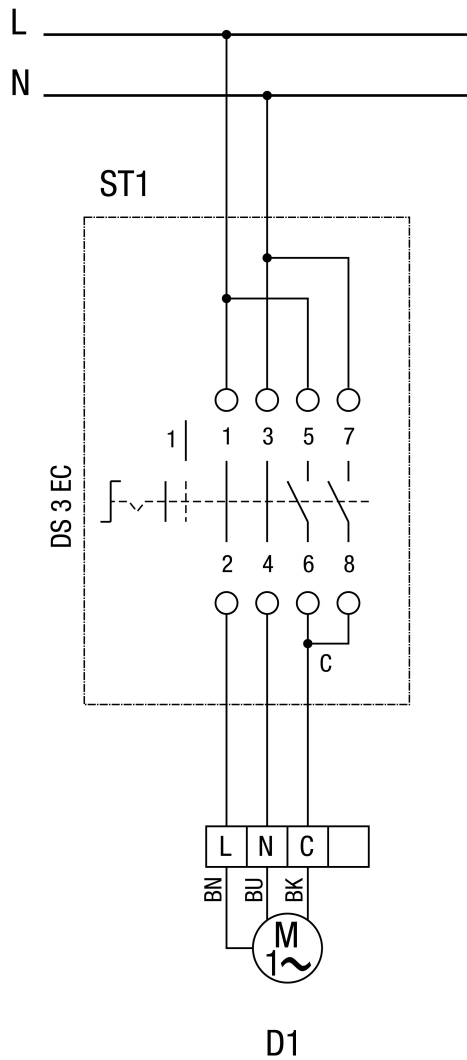

ST 1 = position 1

D1 = speed 1

# WIRING DIAGRAM

## HDR 12 EC

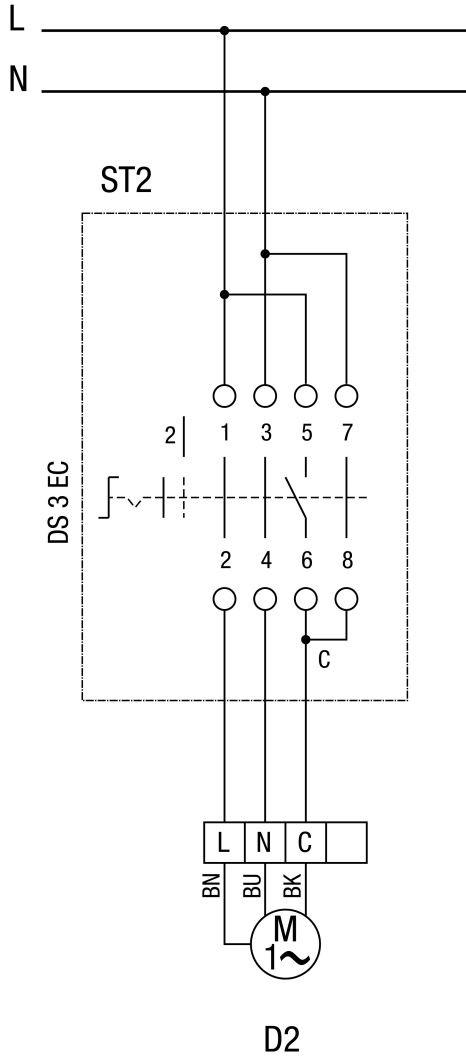

ST 2 = position 2  
D2 = speed 2

# WIRING DIAGRAM

## HDR 12 EC

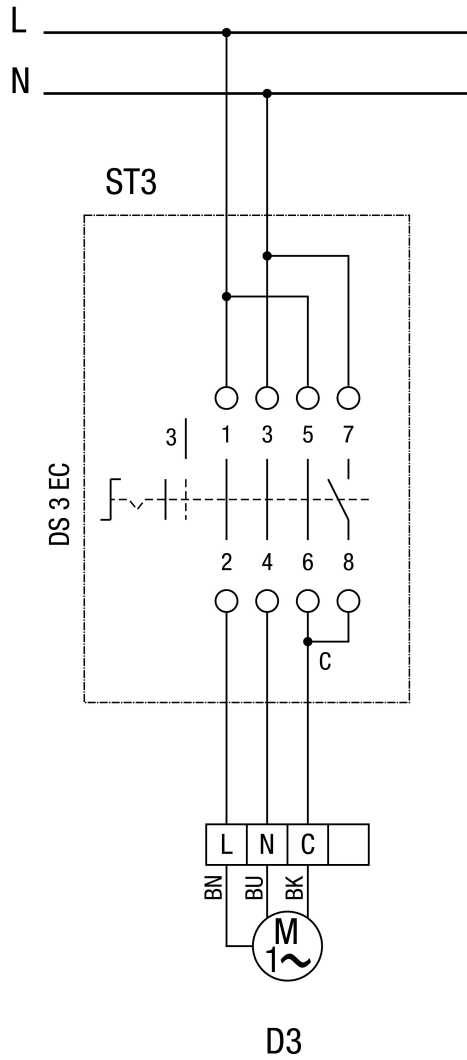

ST 3 = position 3  
D3 = speed 3

# WIRING DIAGRAM

## HDR 12 EC

### RLS 3 room air control for HDR EC duct fan

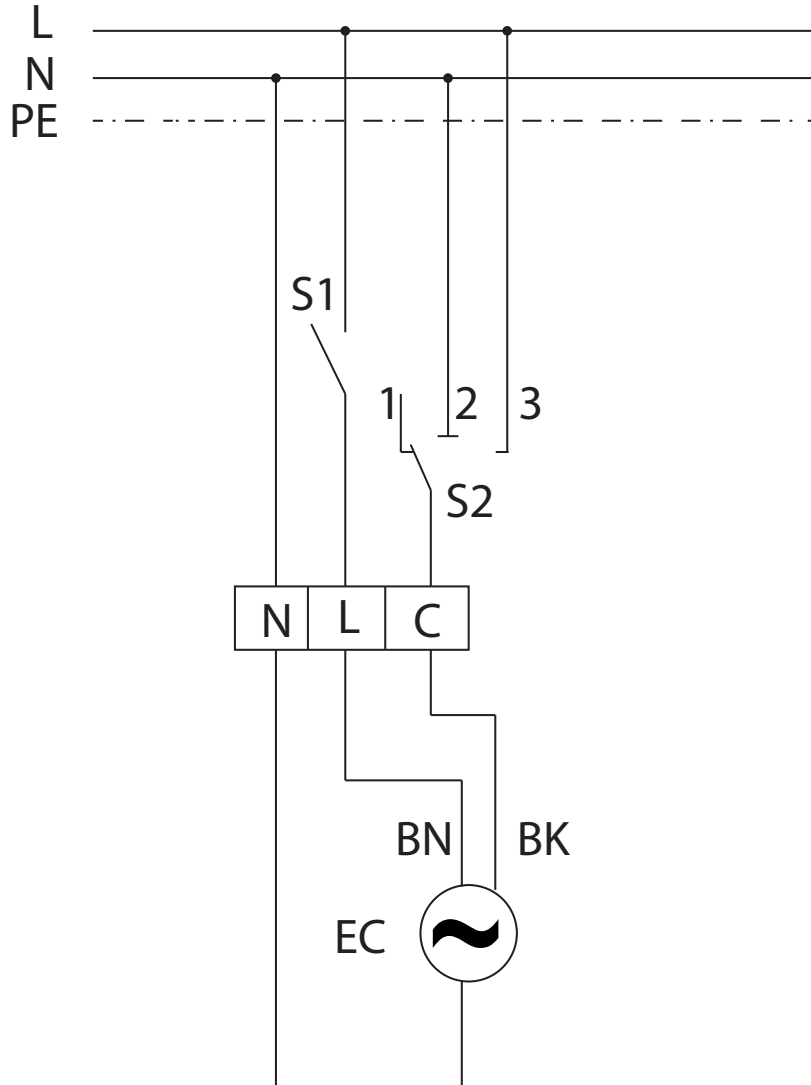

S1 - On/Off  
S2 - Level selector switch

---