

WIRING DIAGRAM

HDR 16 EC

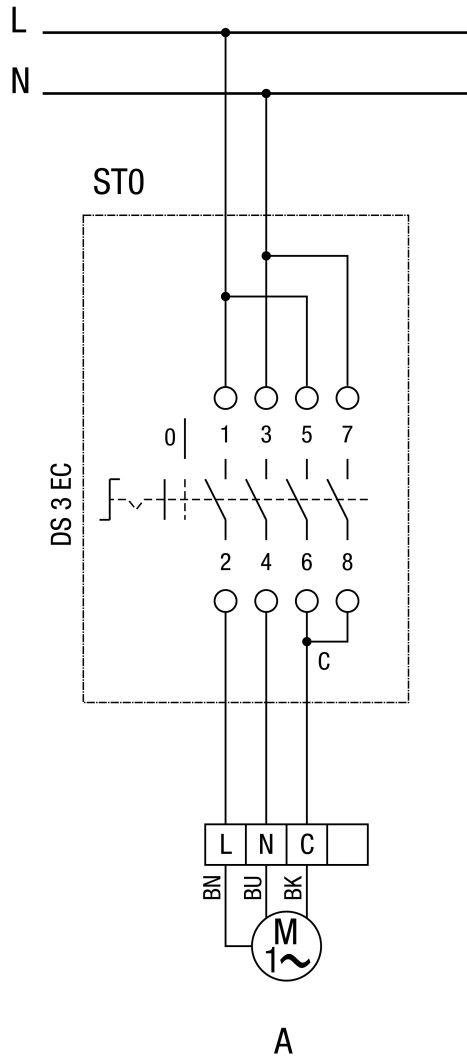

ST0 = position 0
A = Off

WIRING DIAGRAM

HDR 16 EC

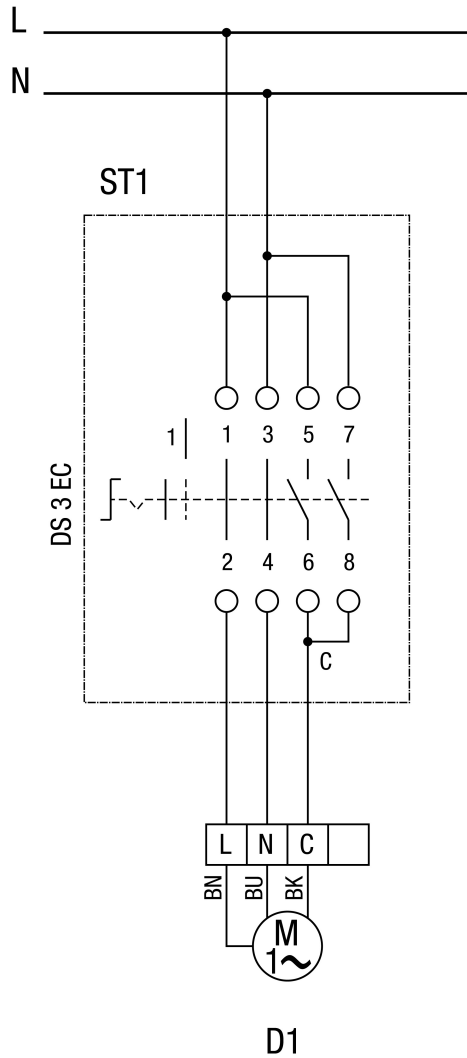

ST 1 = position 1
D1 = speed 1

WIRING DIAGRAM

HDR 16 EC

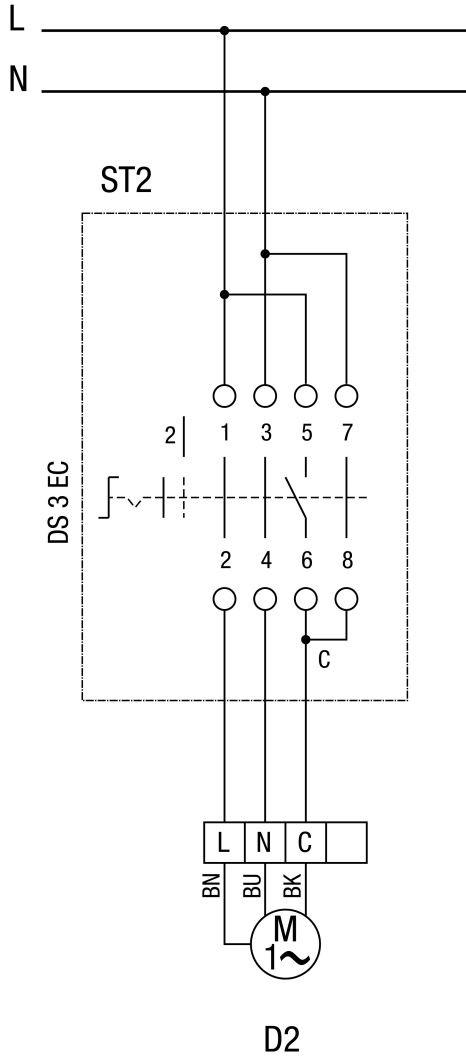

ST 2 = position 2
D2 = speed 2

WIRING DIAGRAM

HDR 16 EC

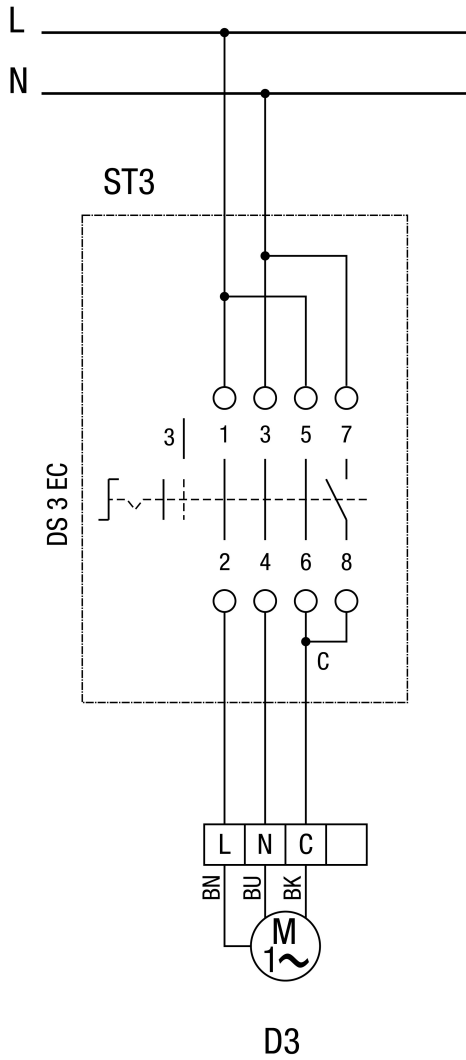

ST 3 = position 3
D3 = speed 3

WIRING DIAGRAM

HDR 16 EC

RLS 3 room air control for HDR EC duct fan

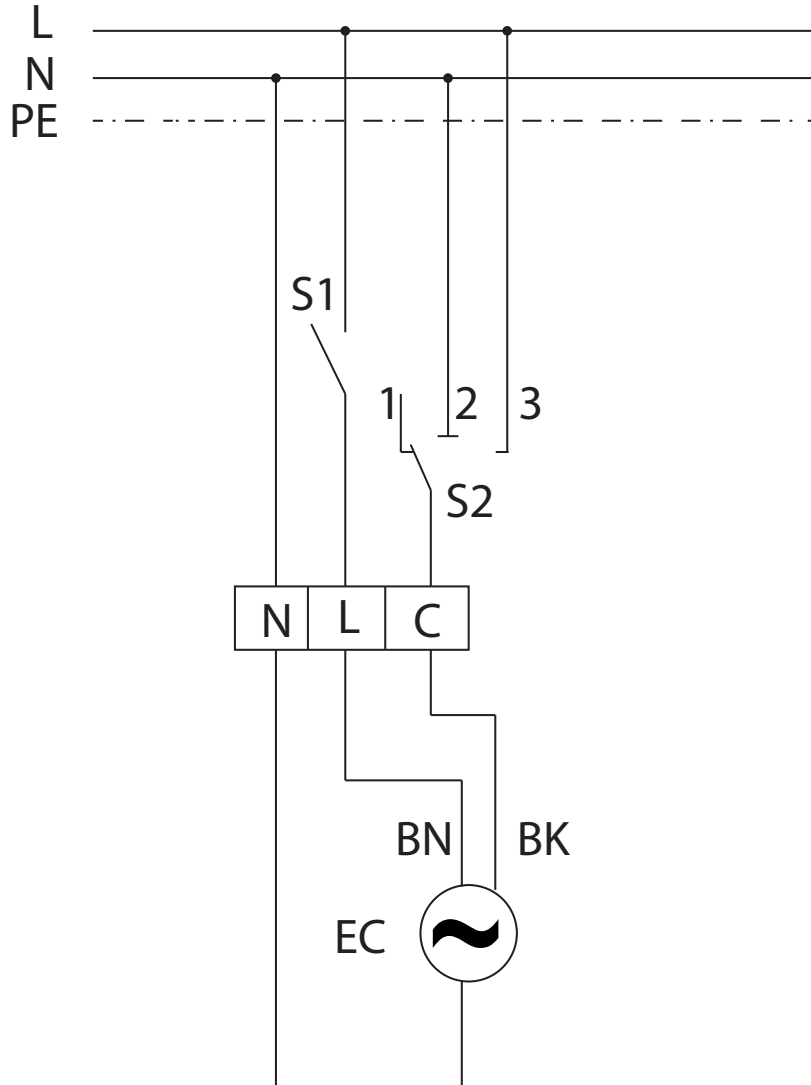

S1 - On/Off
S2 - Level selector switch
