

WIRING DIAGRAM

MDR 45 EC

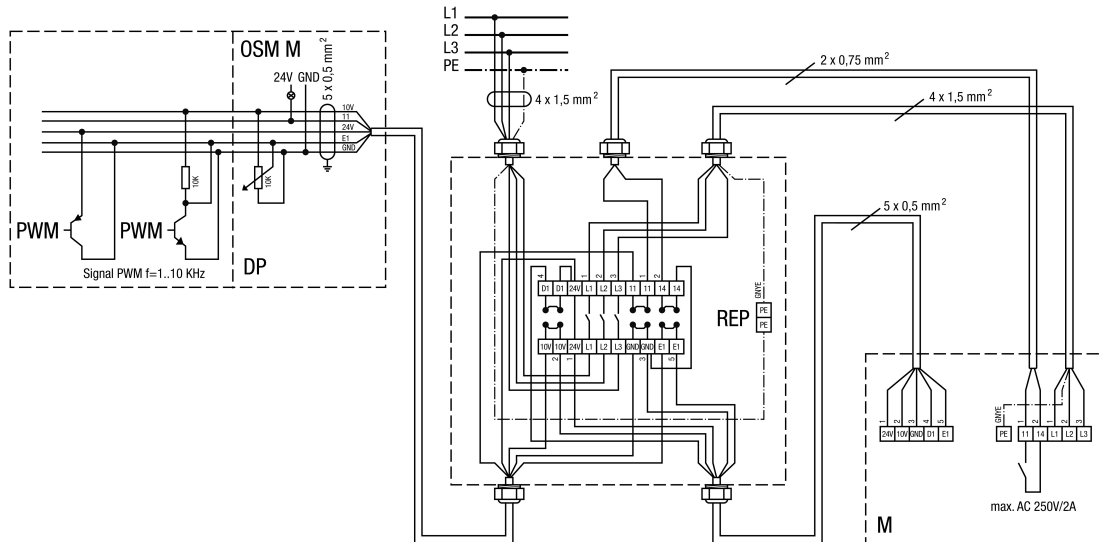

- L1/N - Power supply 230V/50Hz
- PE PE conductor
- 24V - Power supply 24 VDC
- 10 V / GND - 10 VDC power supply
- E1 - Control voltage Speed input (0-10V)
- D1 - Enabling contact
- 11/14 - Potential-free contact Motor
- PWM - PWM speed control
- DP - Speed control potentiometer
- OSM M - Option Motor fault signal
- REP - Repair switch
- M - Motor