

# WIRING DIAGRAM

## TRE 3,3-2

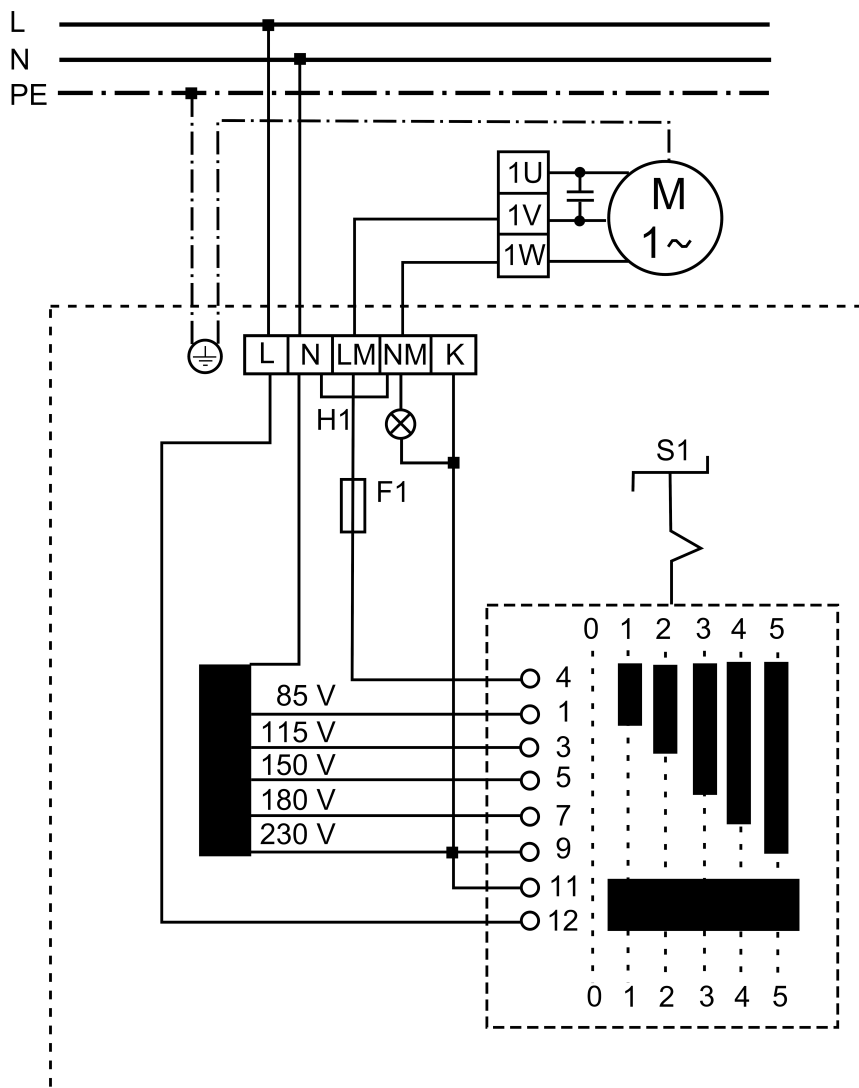

- H1 - Operation (green)
- S1 - Switch: On/Off
- M1 - Fan motor
- K - Connection for external shutter