

WIRING DIAGRAM

TRV 1,7-1

TRV 1 / 1.7 / 2.5 / 5 / 11

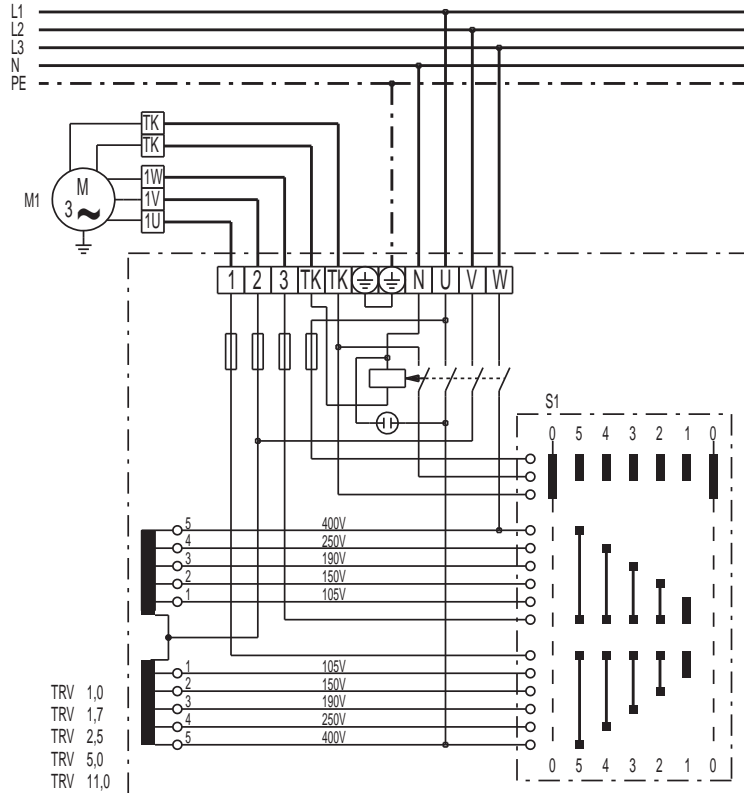

S1 switch: On / Off
M1 fan (three-phase AC motor)