

WIRING DIAGRAM

TR 0,8-2

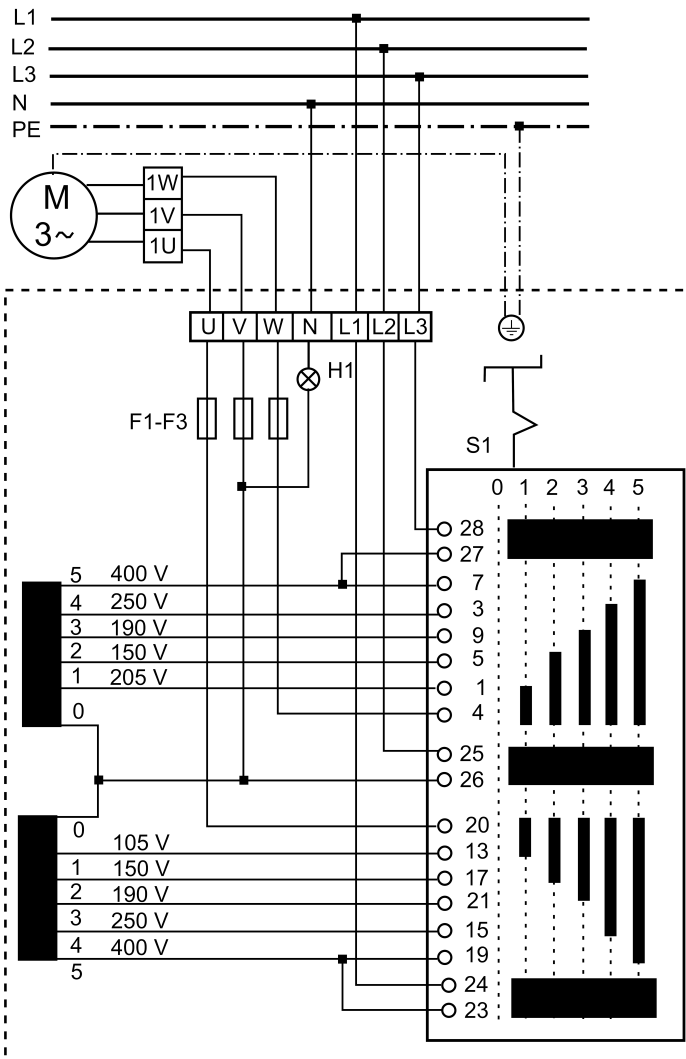

- H1 - operation (green)
- S1 - Switch: On/Off
- M1 - fan motor (three-phase AC)